

1

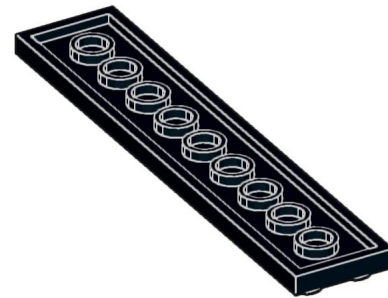

2

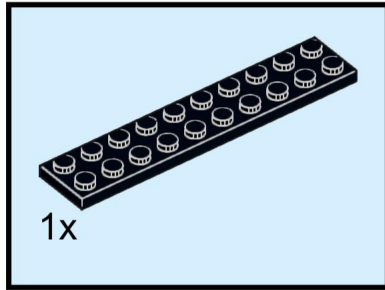
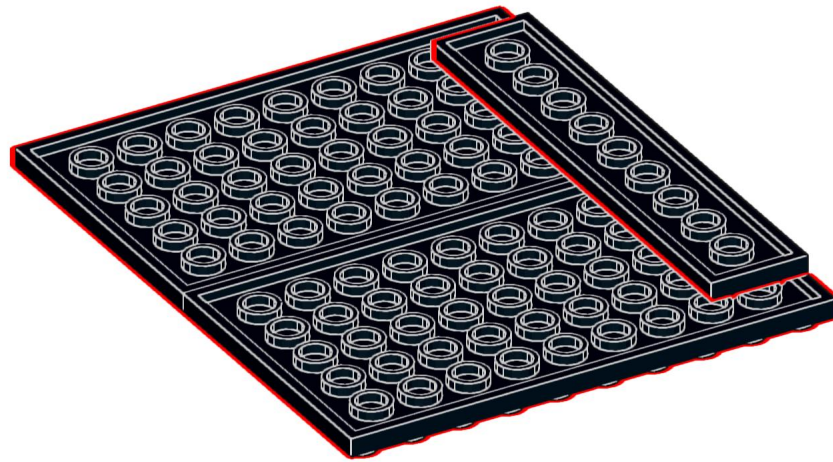
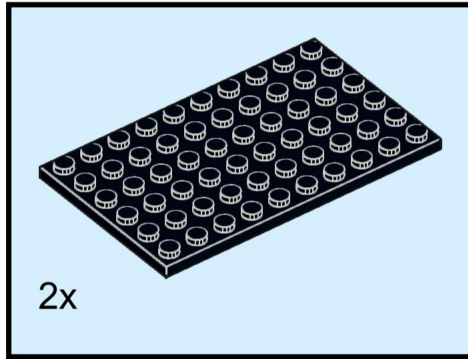

3

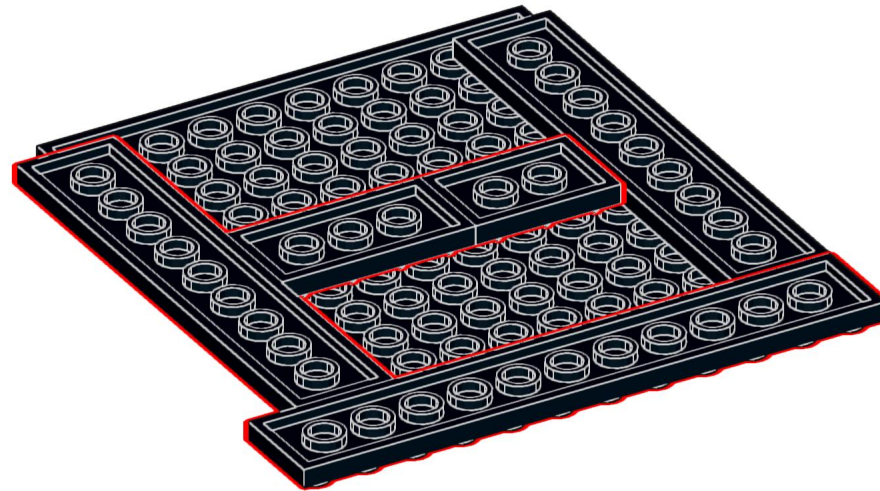
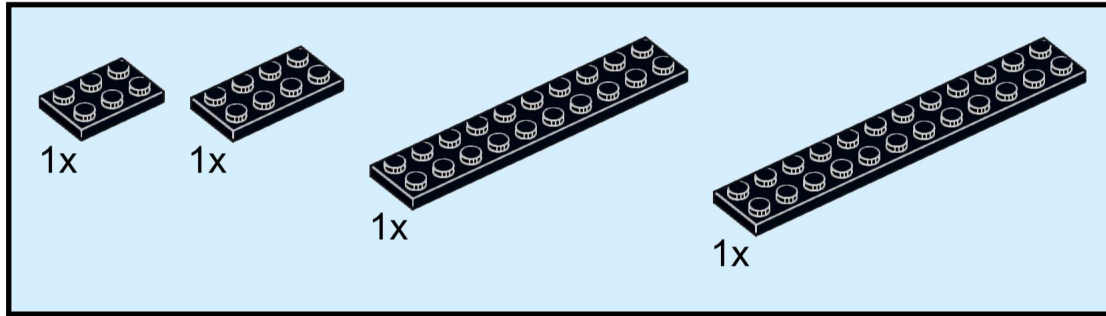

4

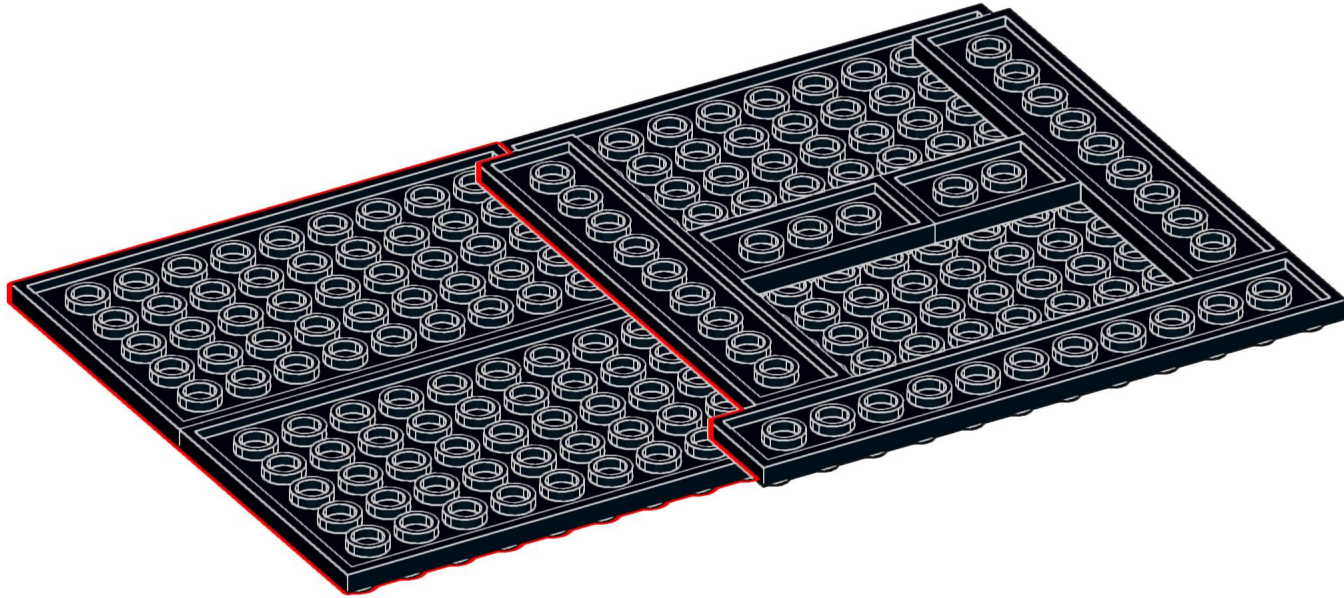
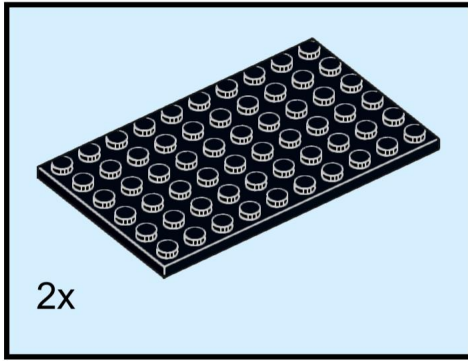

5

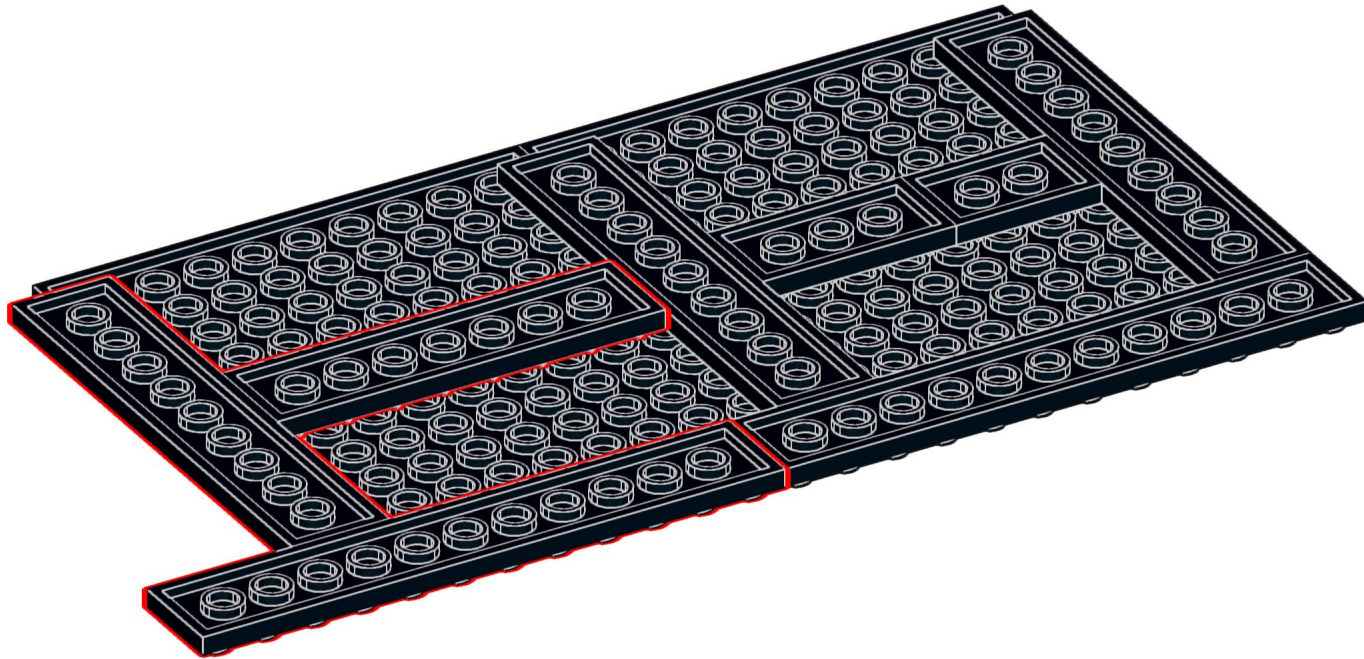
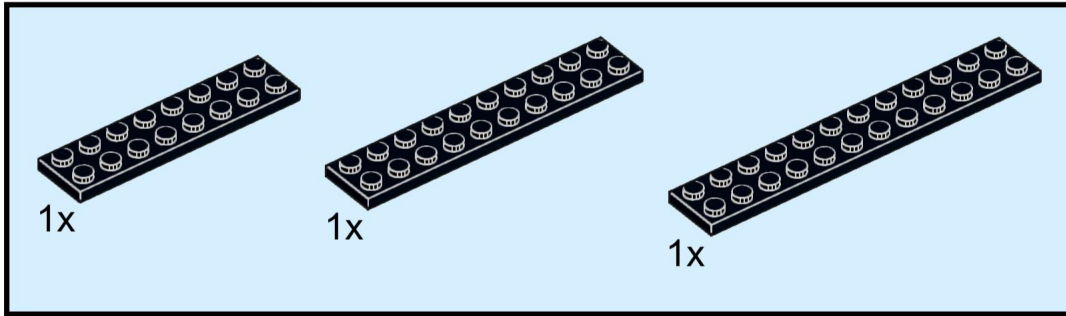

6

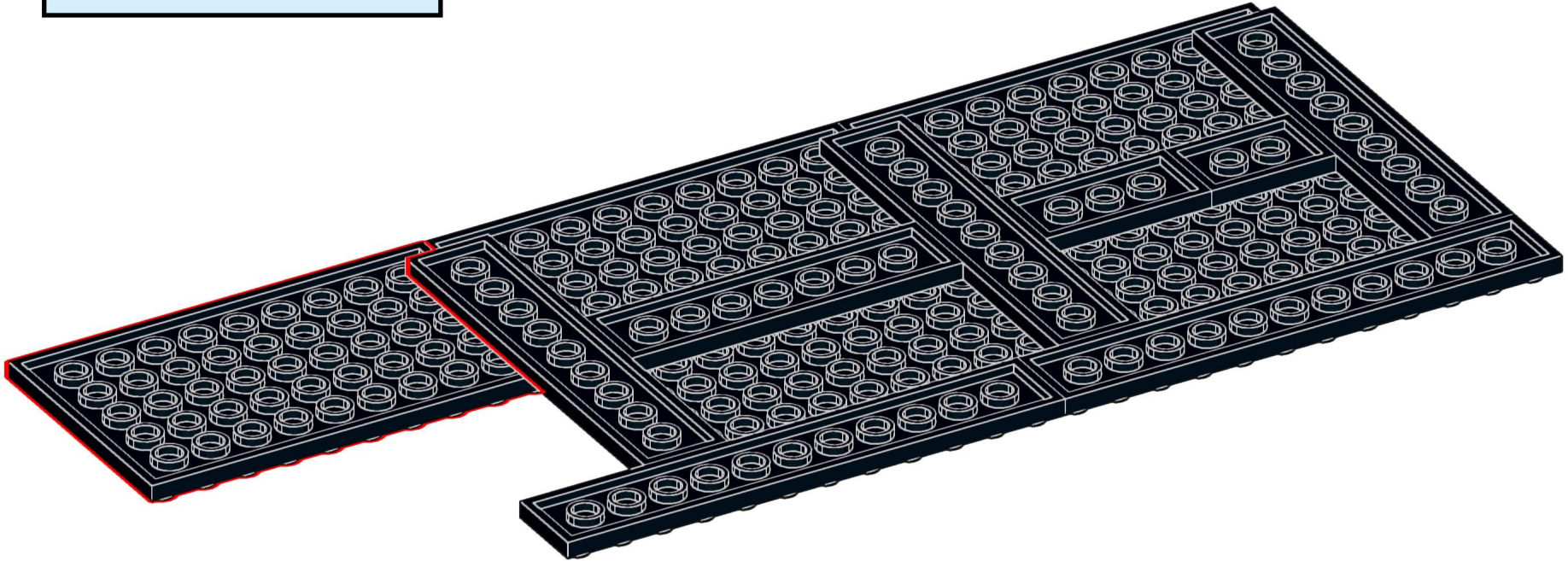
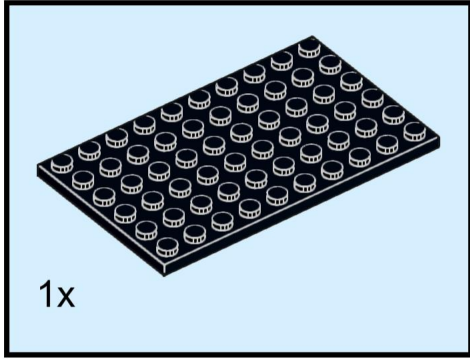

7

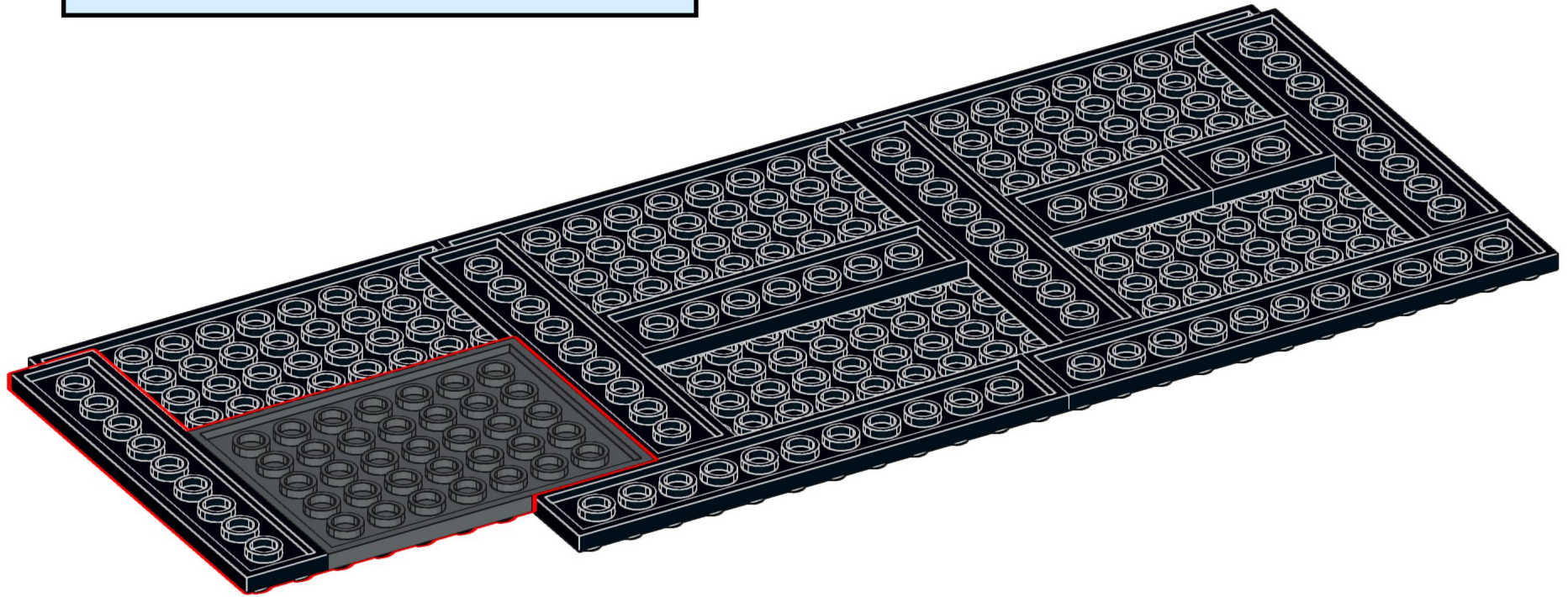
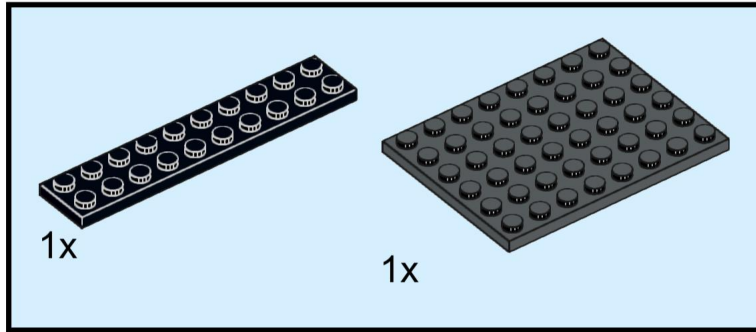

8

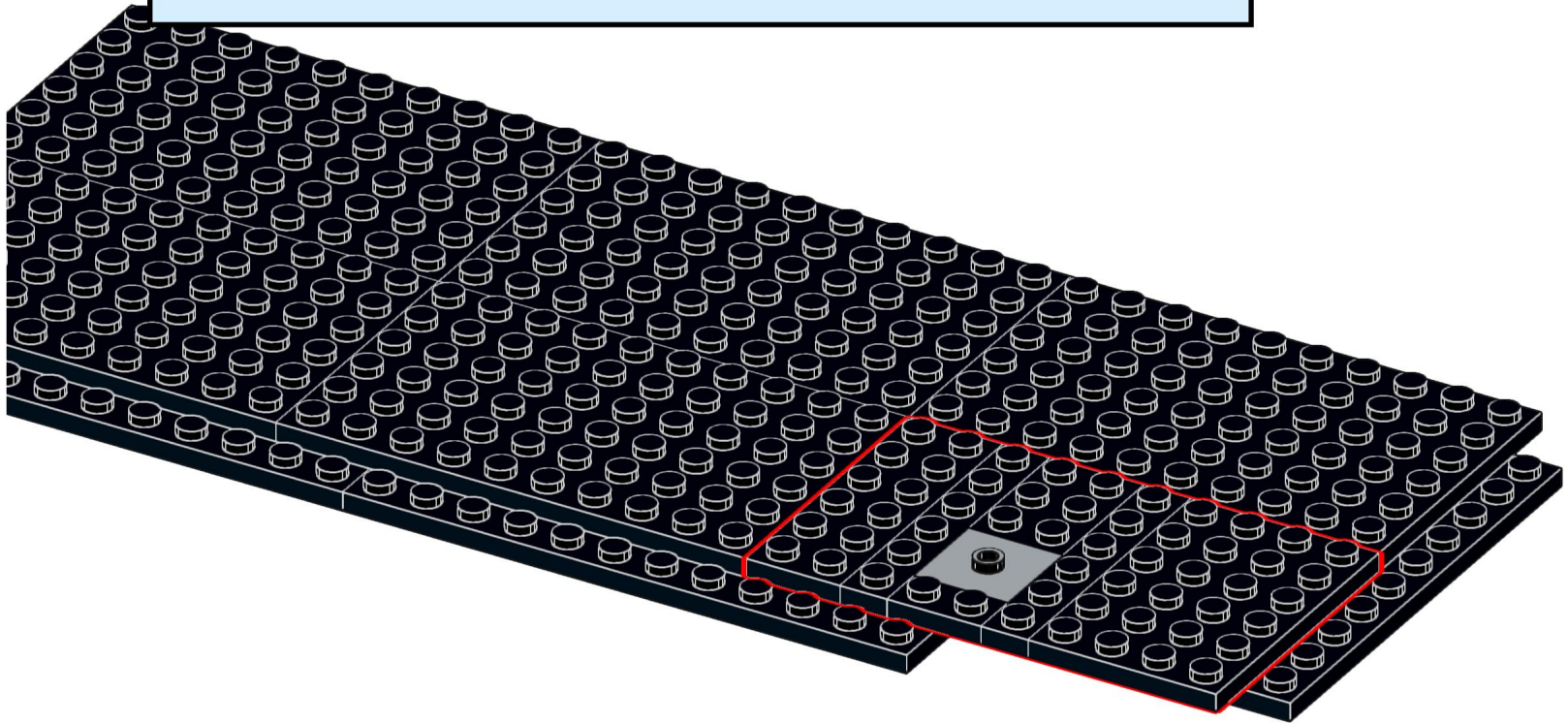
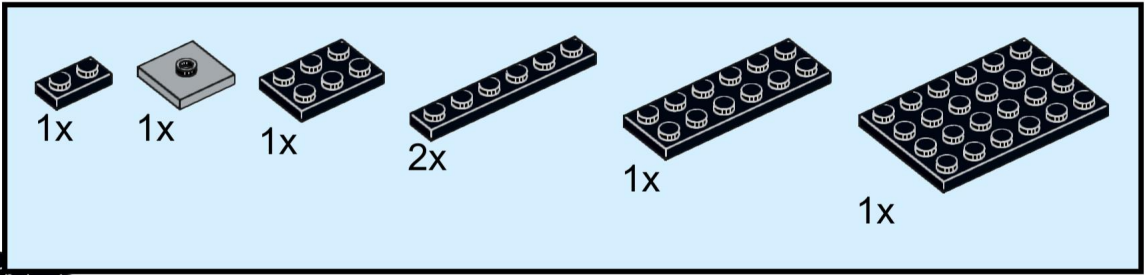

9

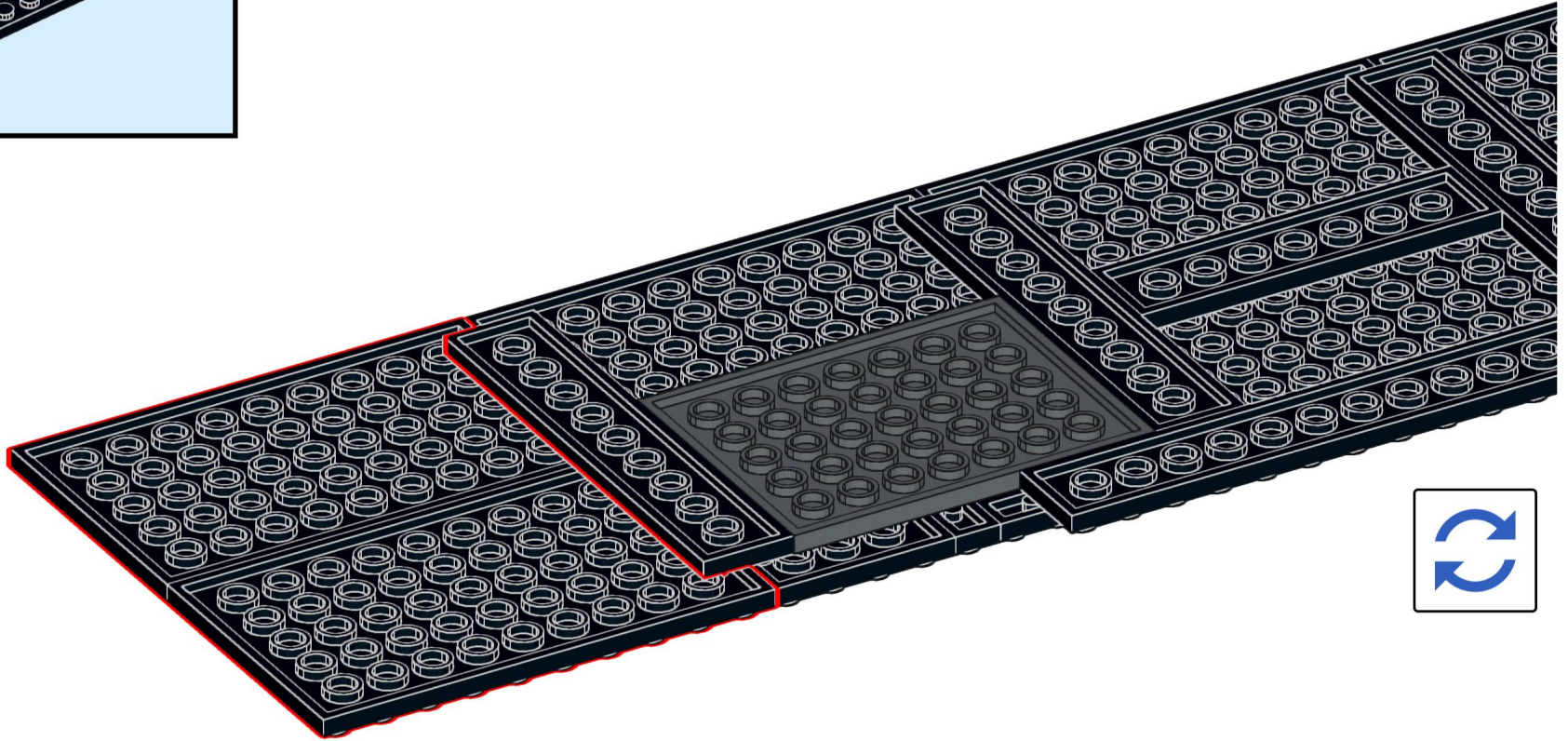
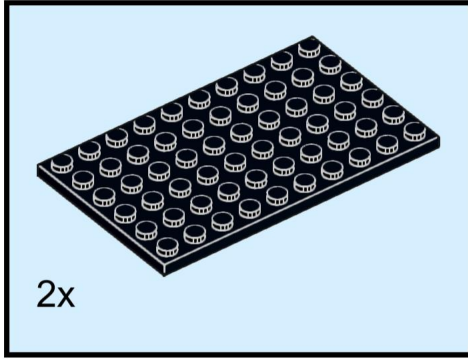

10

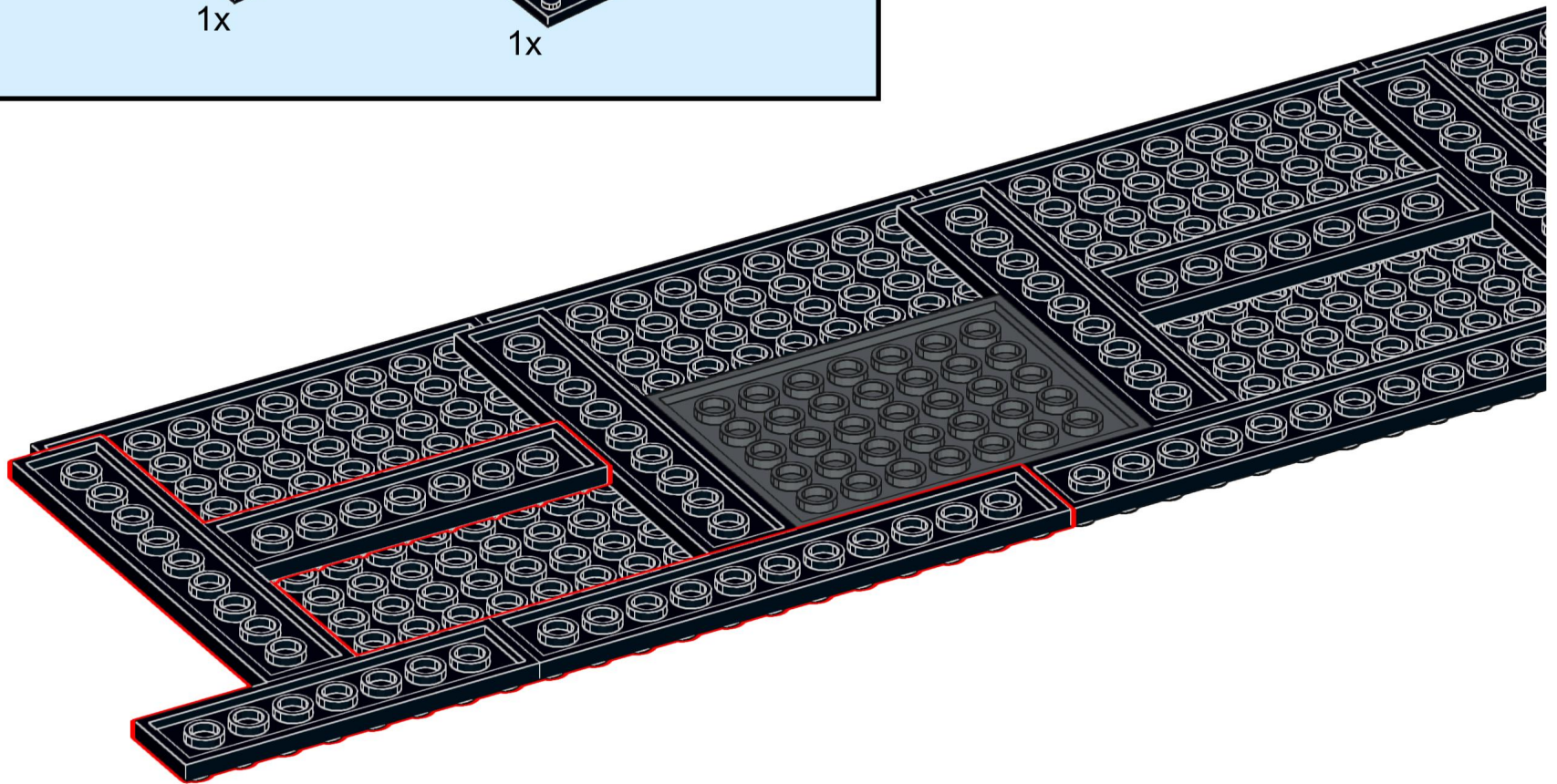
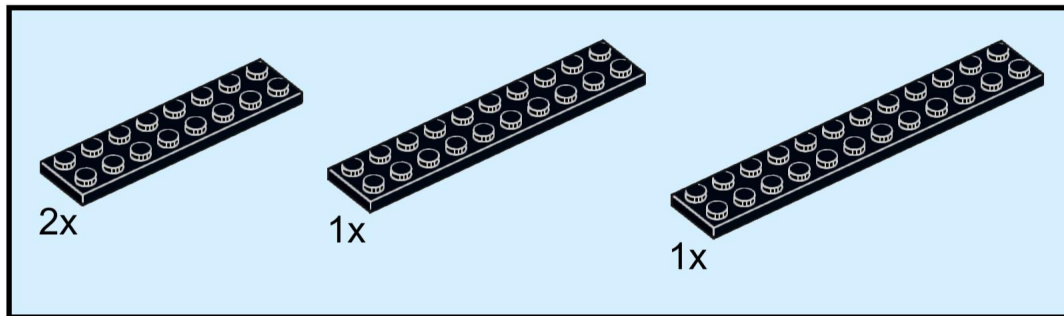

11

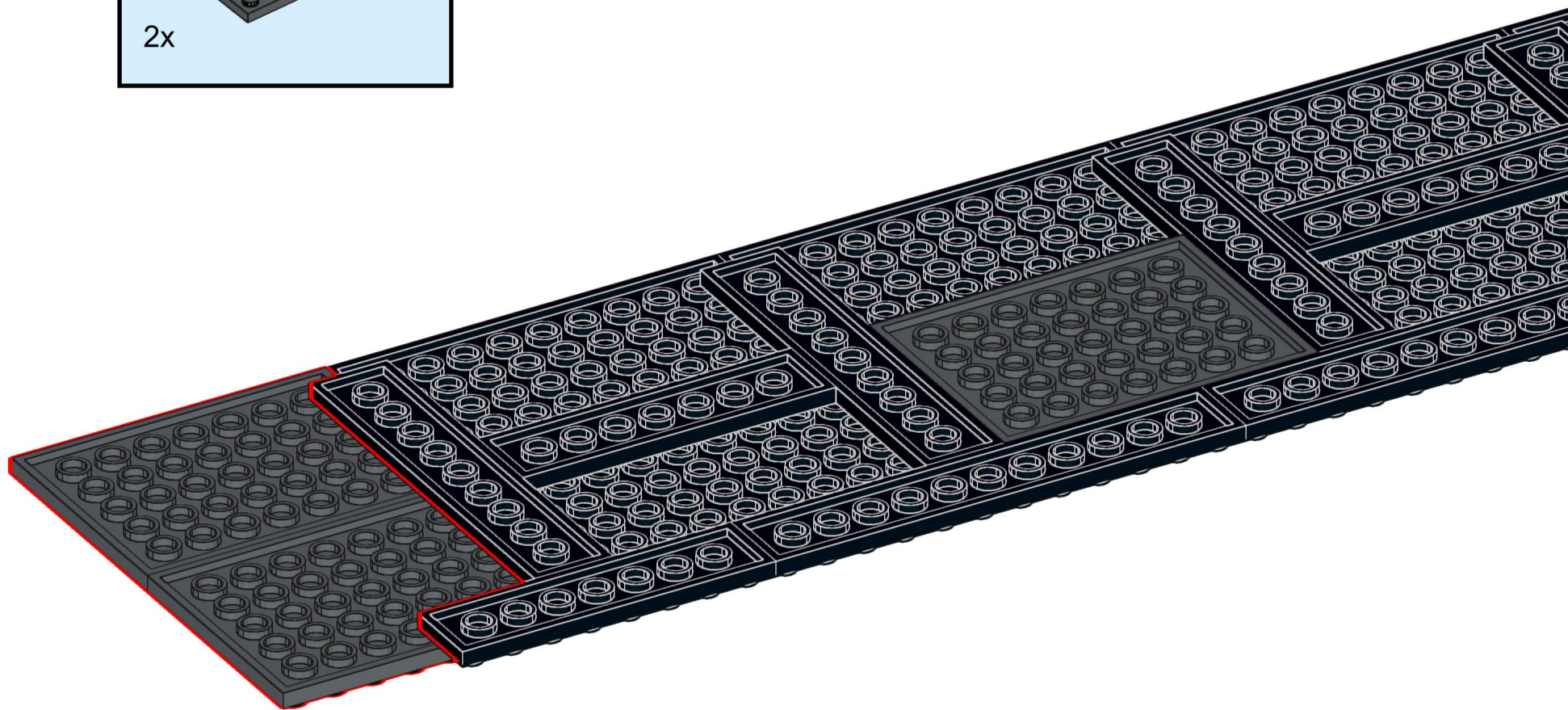
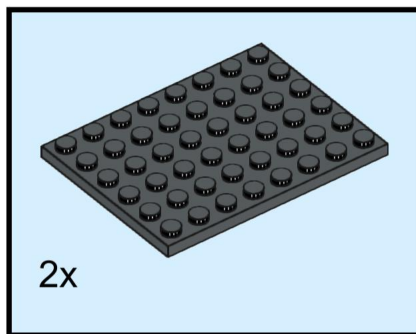

12

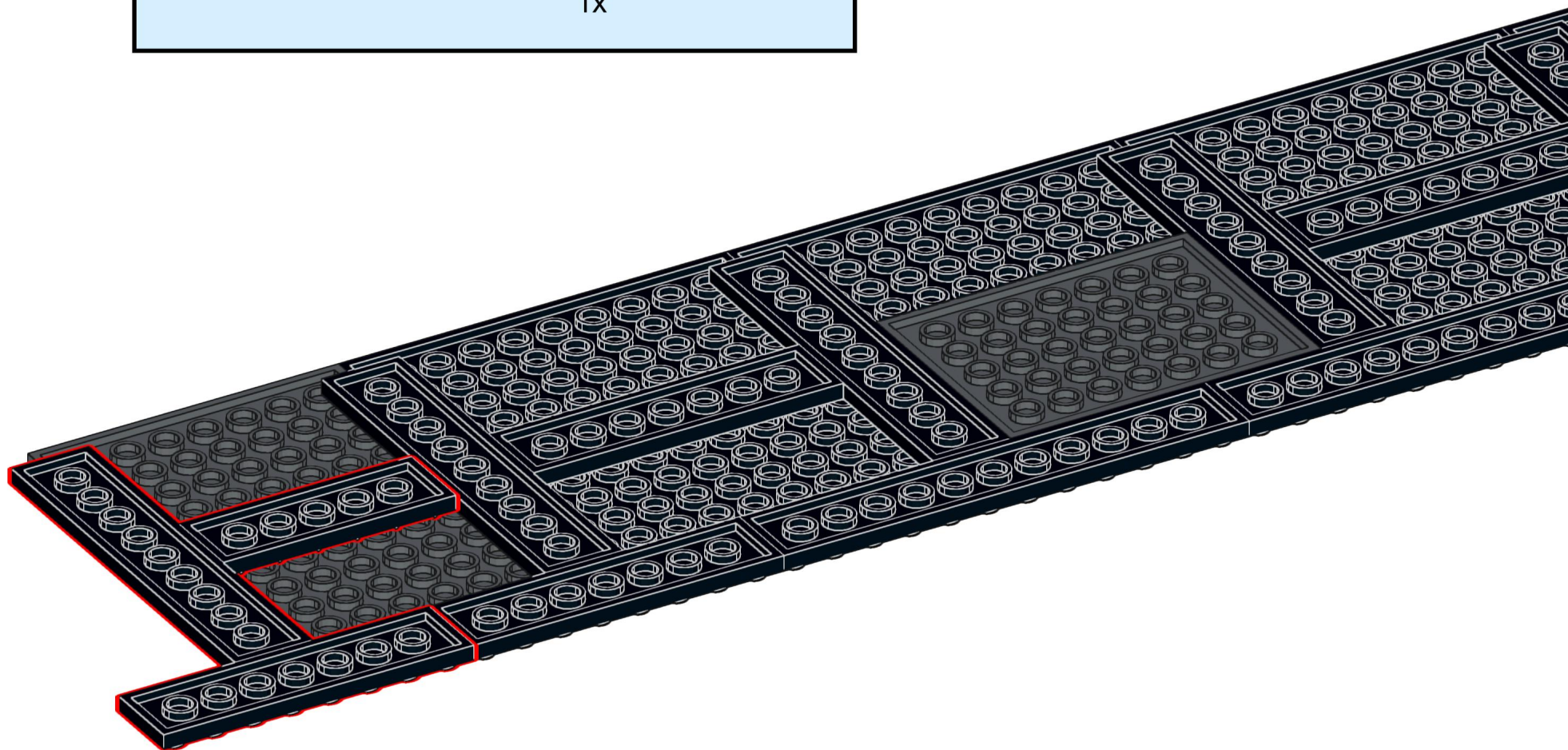
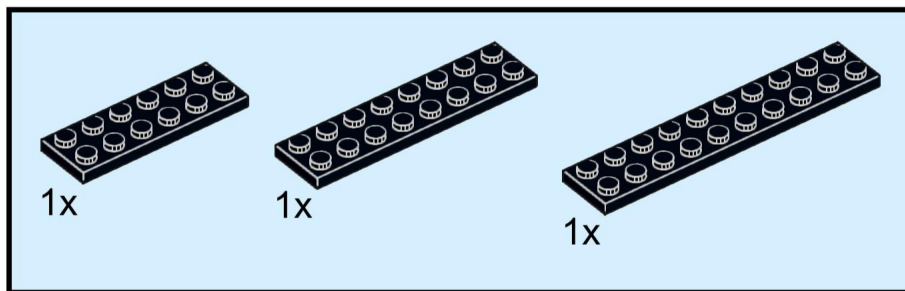

13

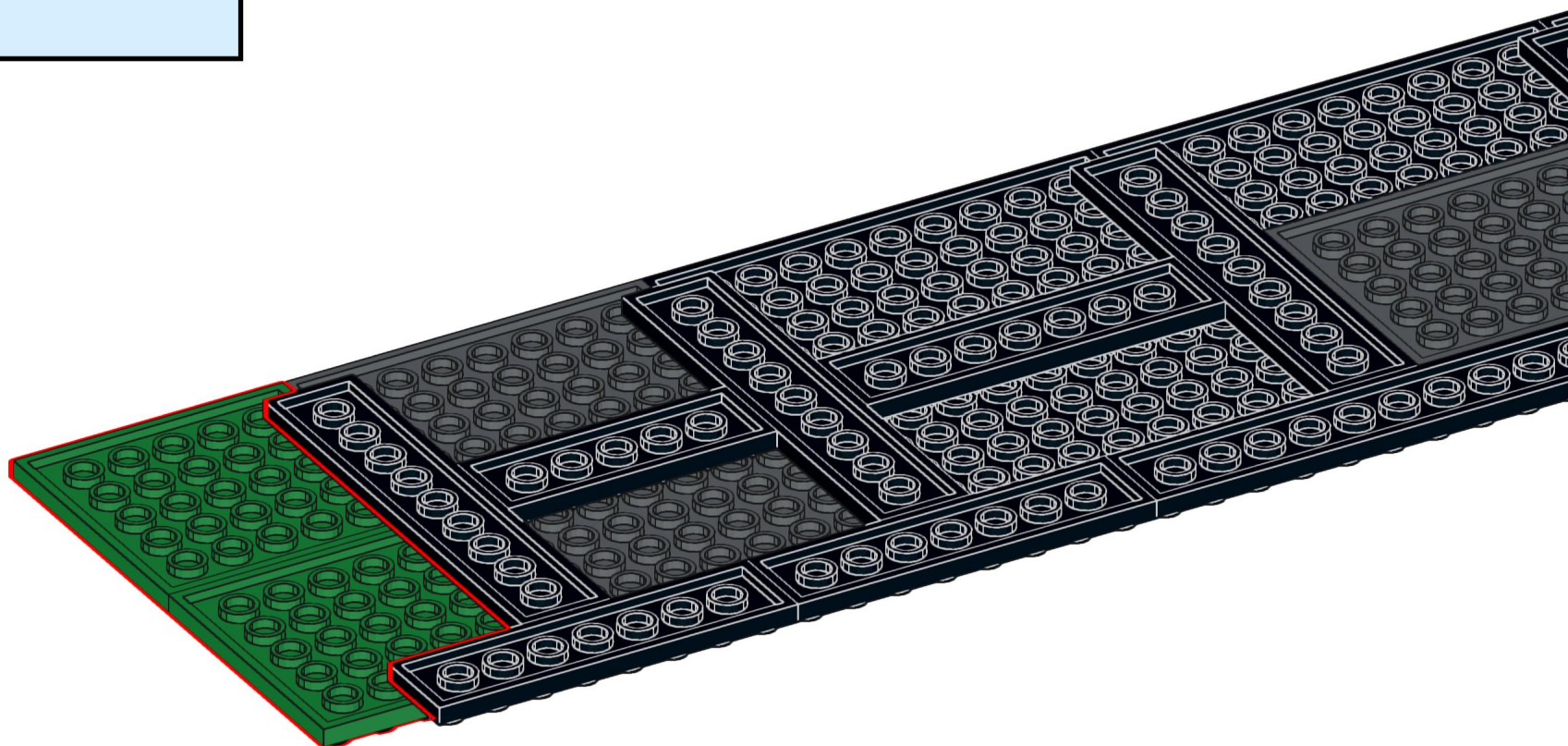
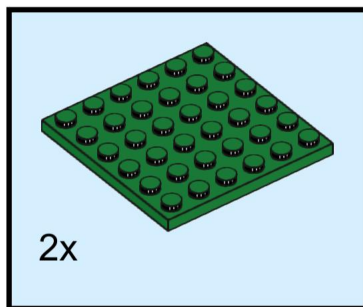

14

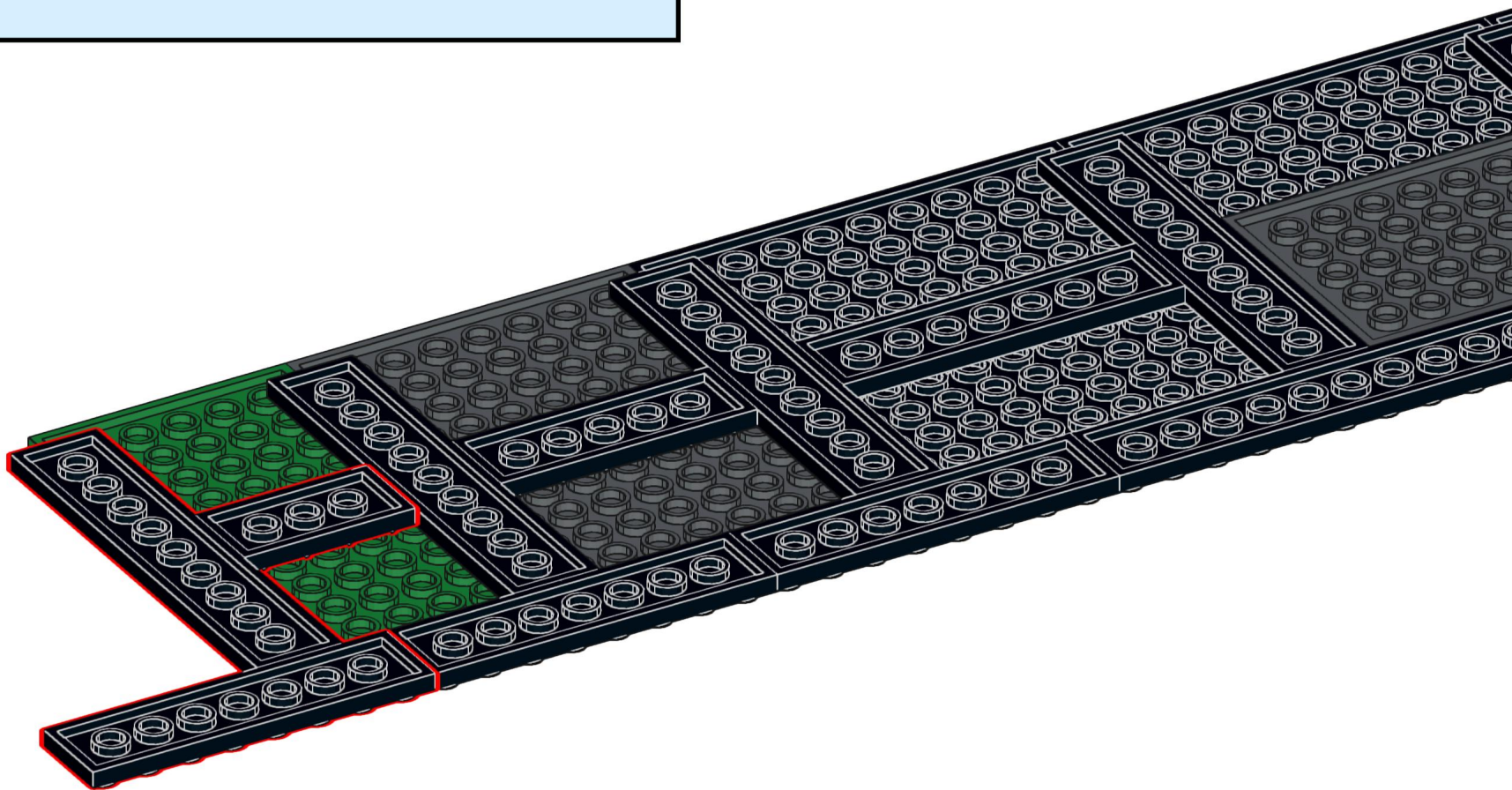
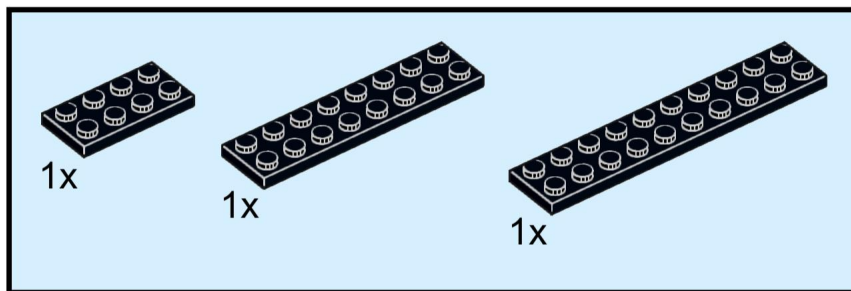

15

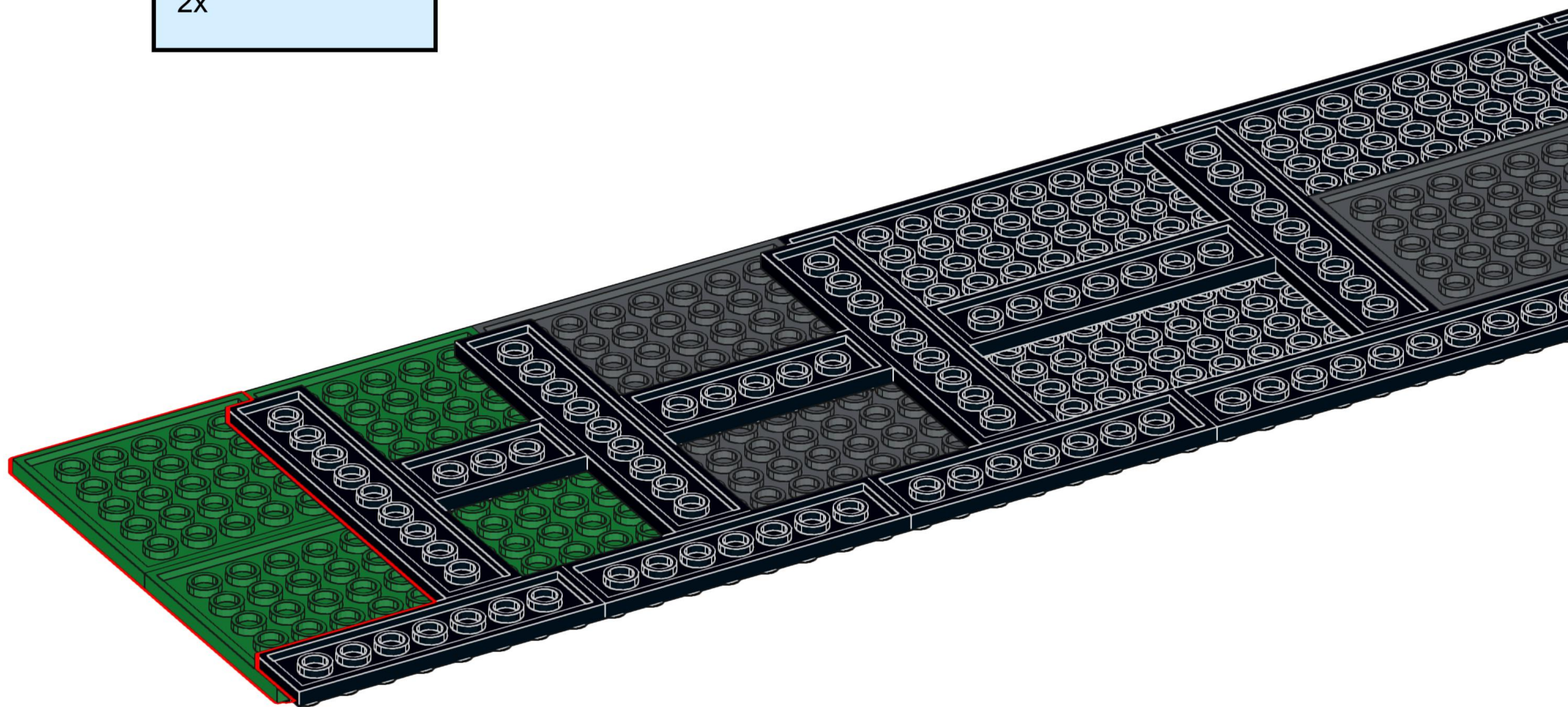
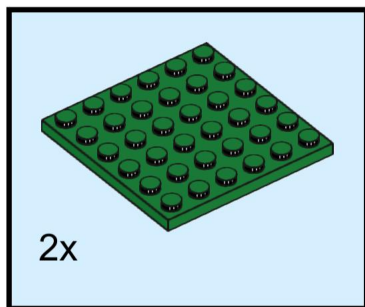

16

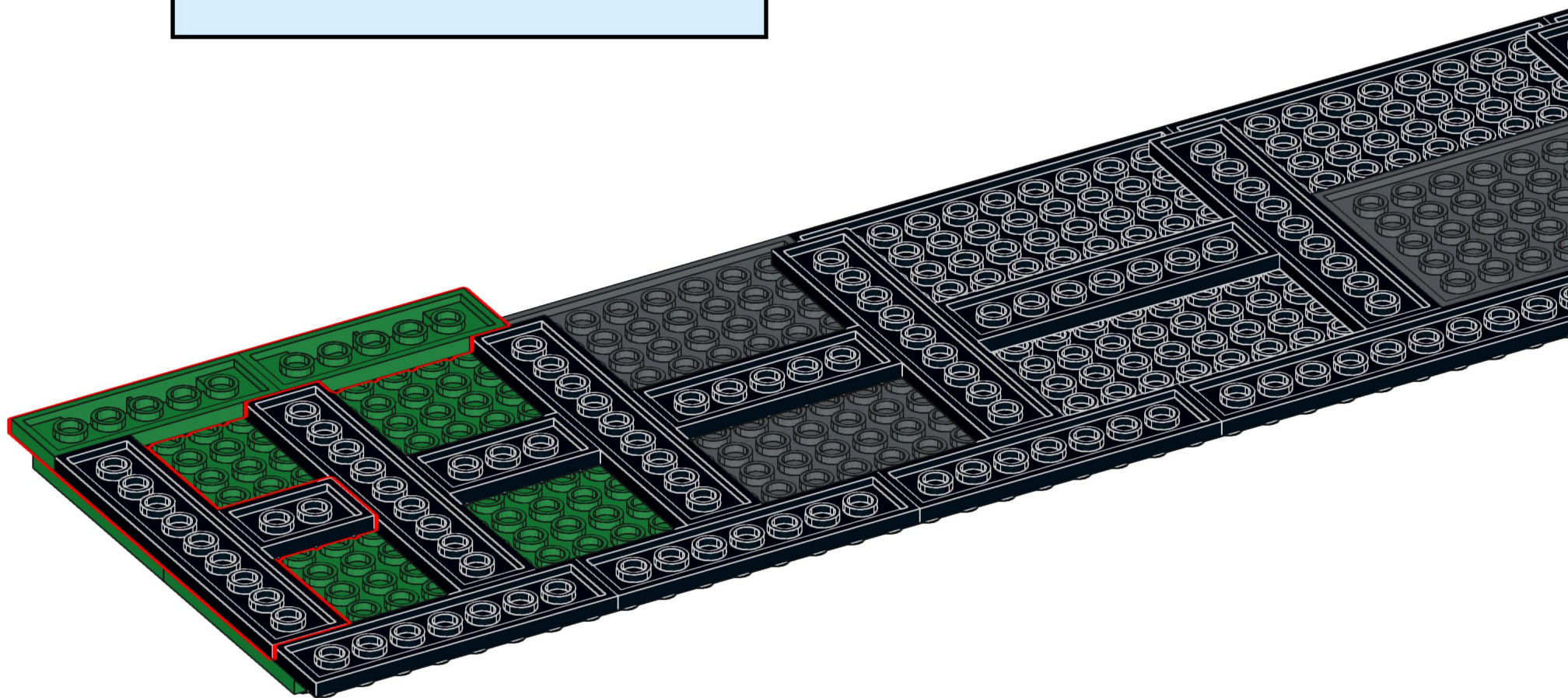
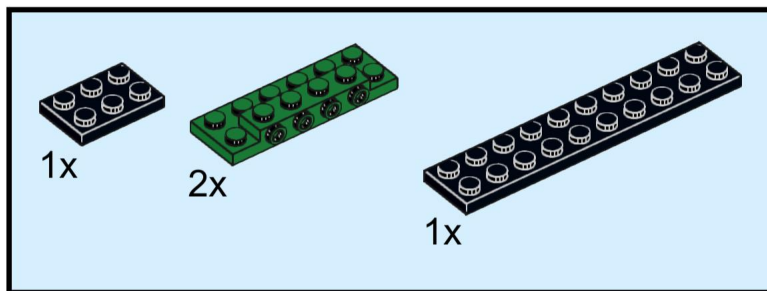

17

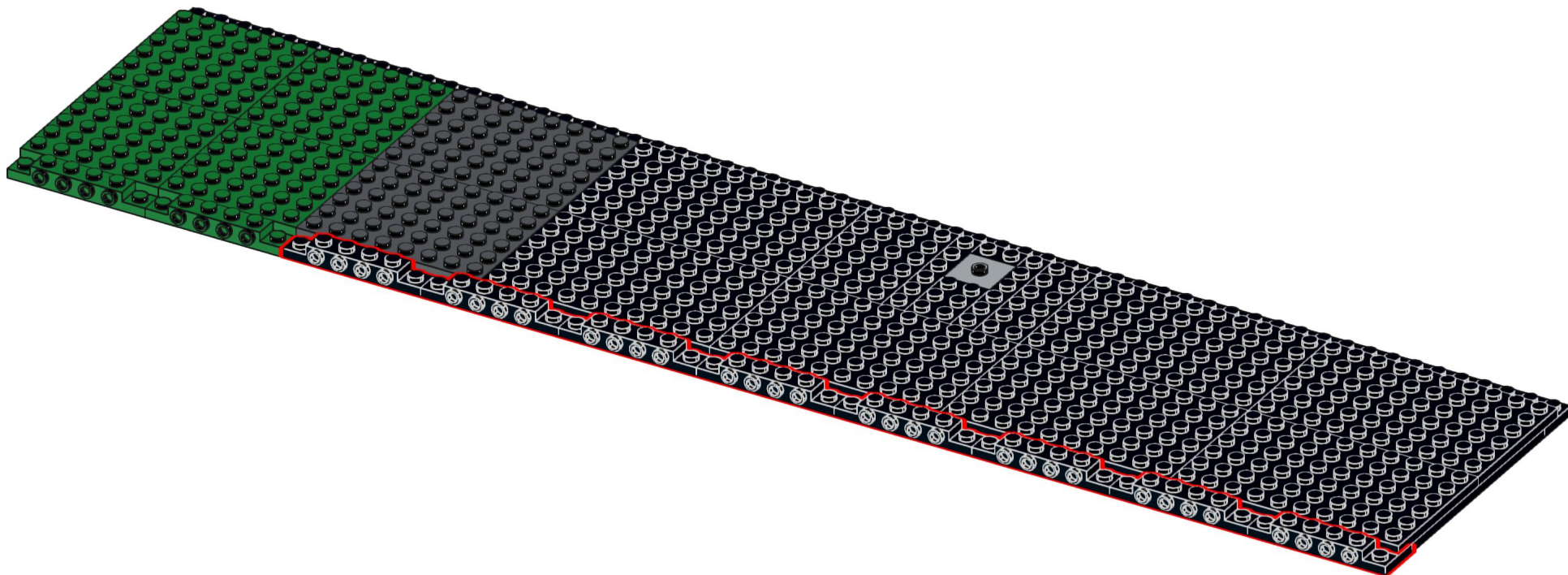
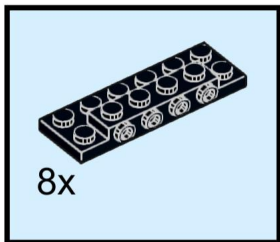

18

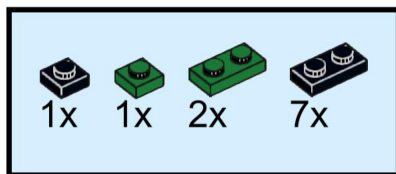

19

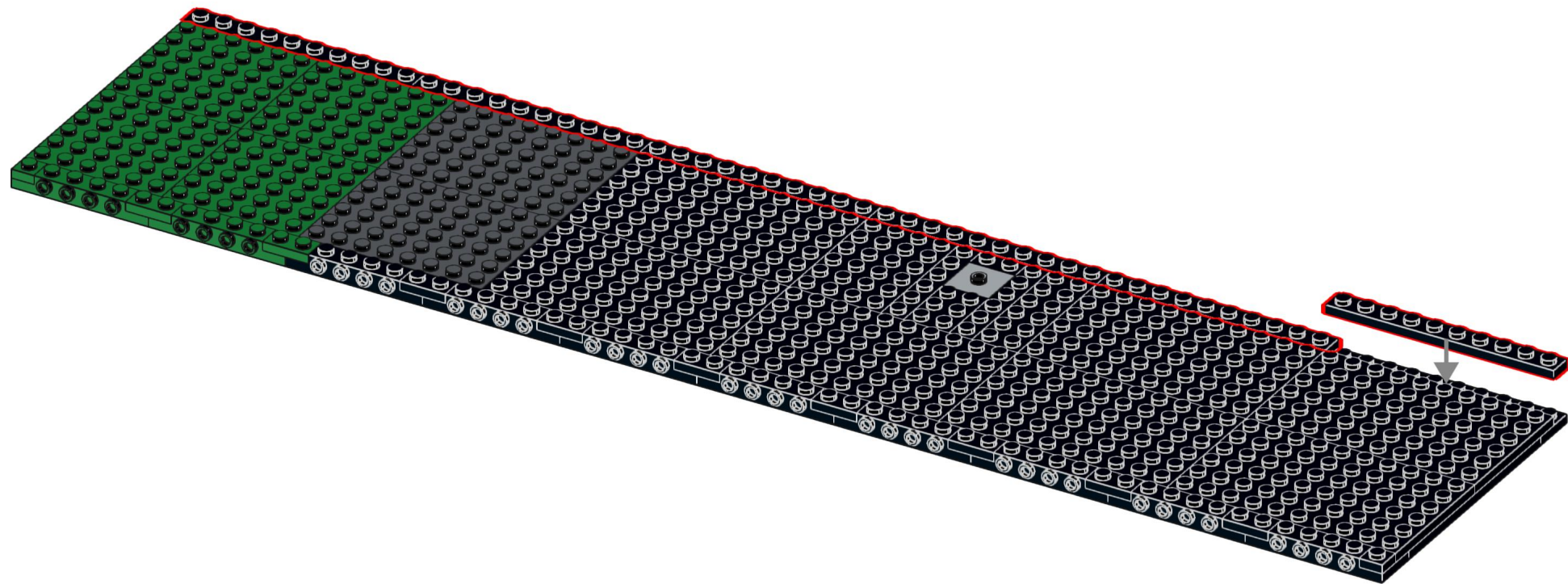
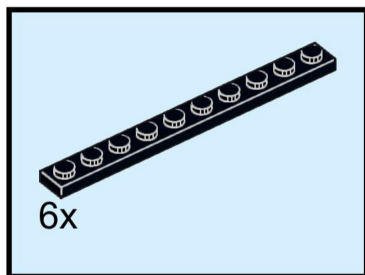

20

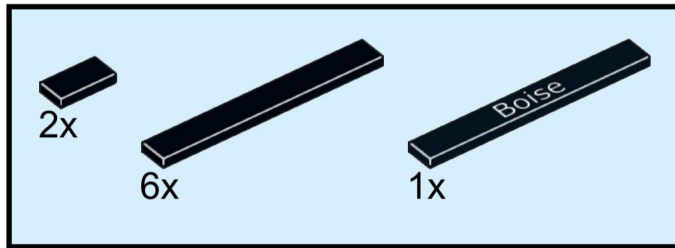

21

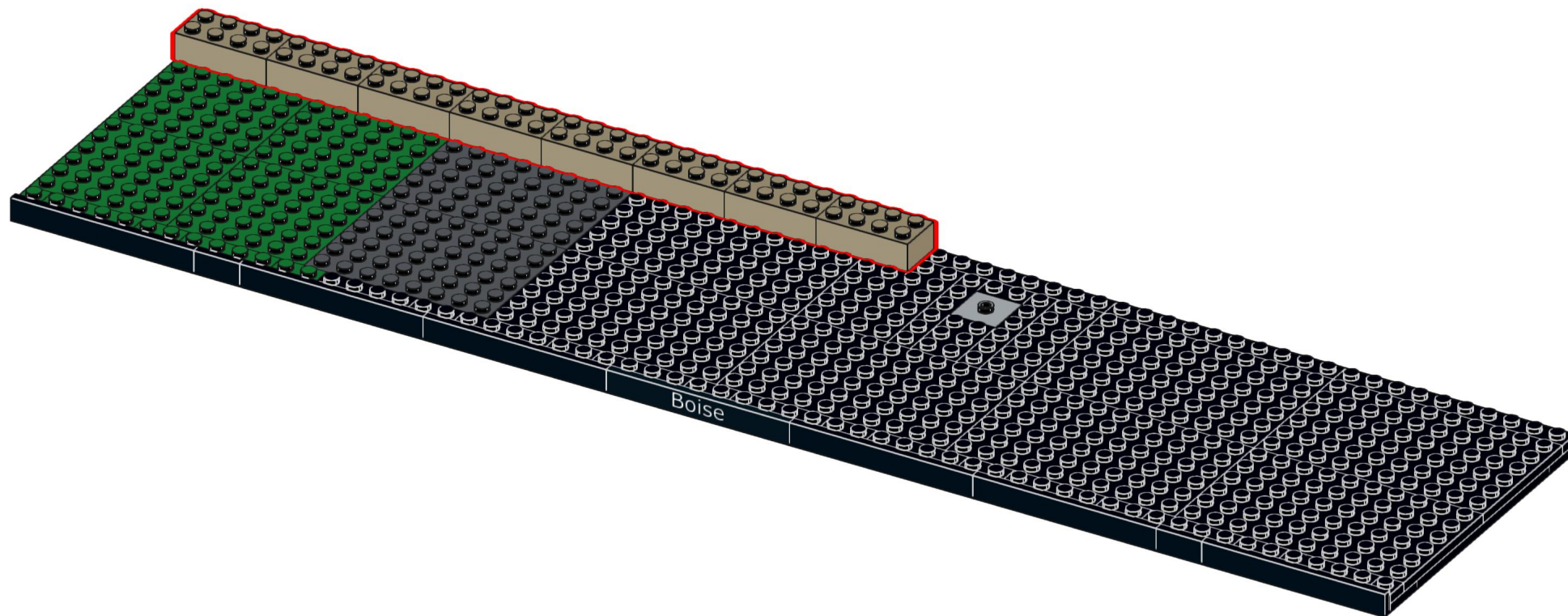
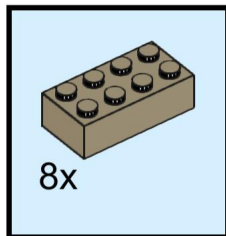

22

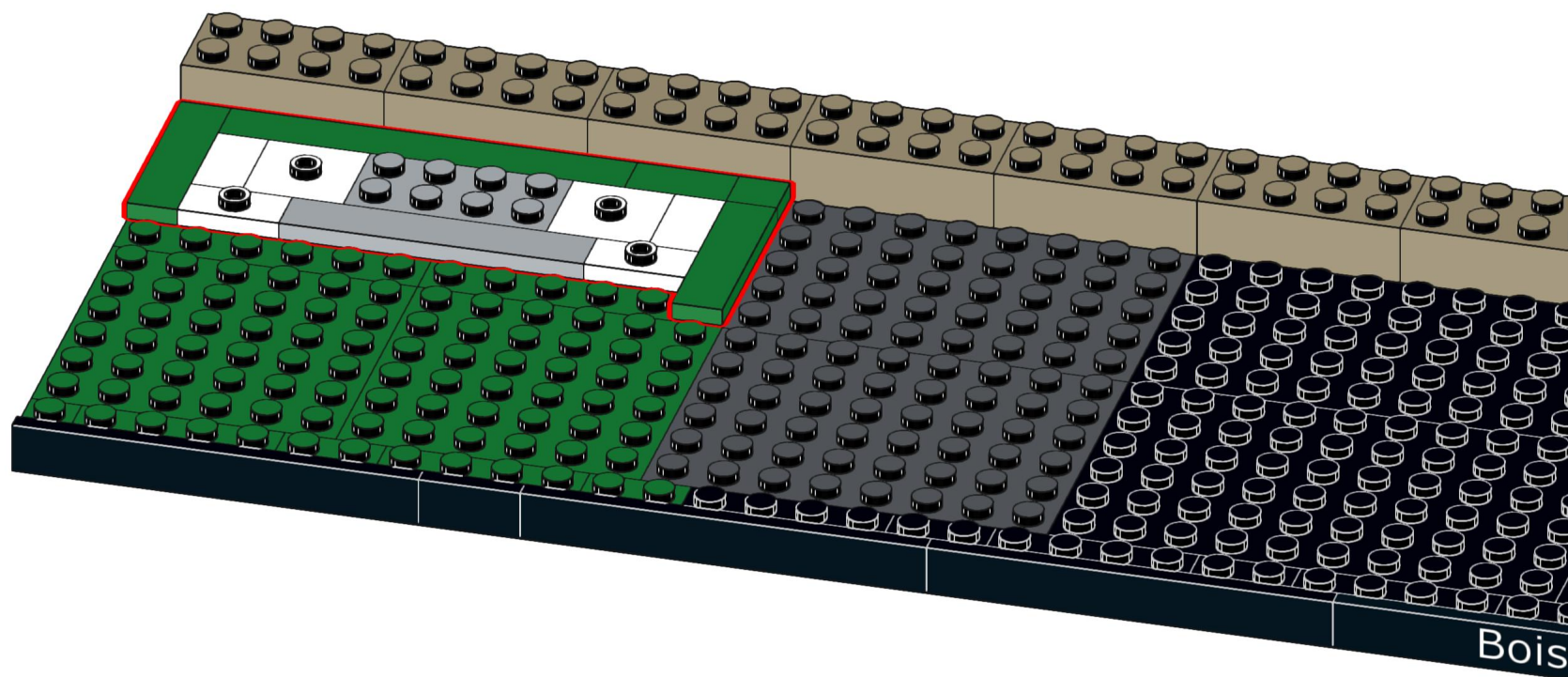
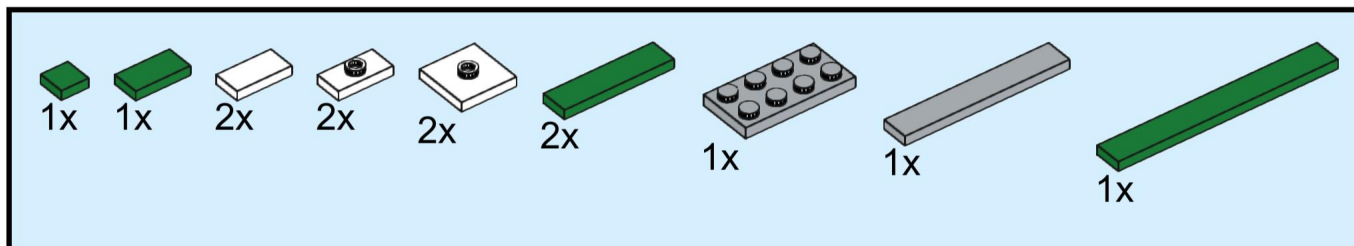

24

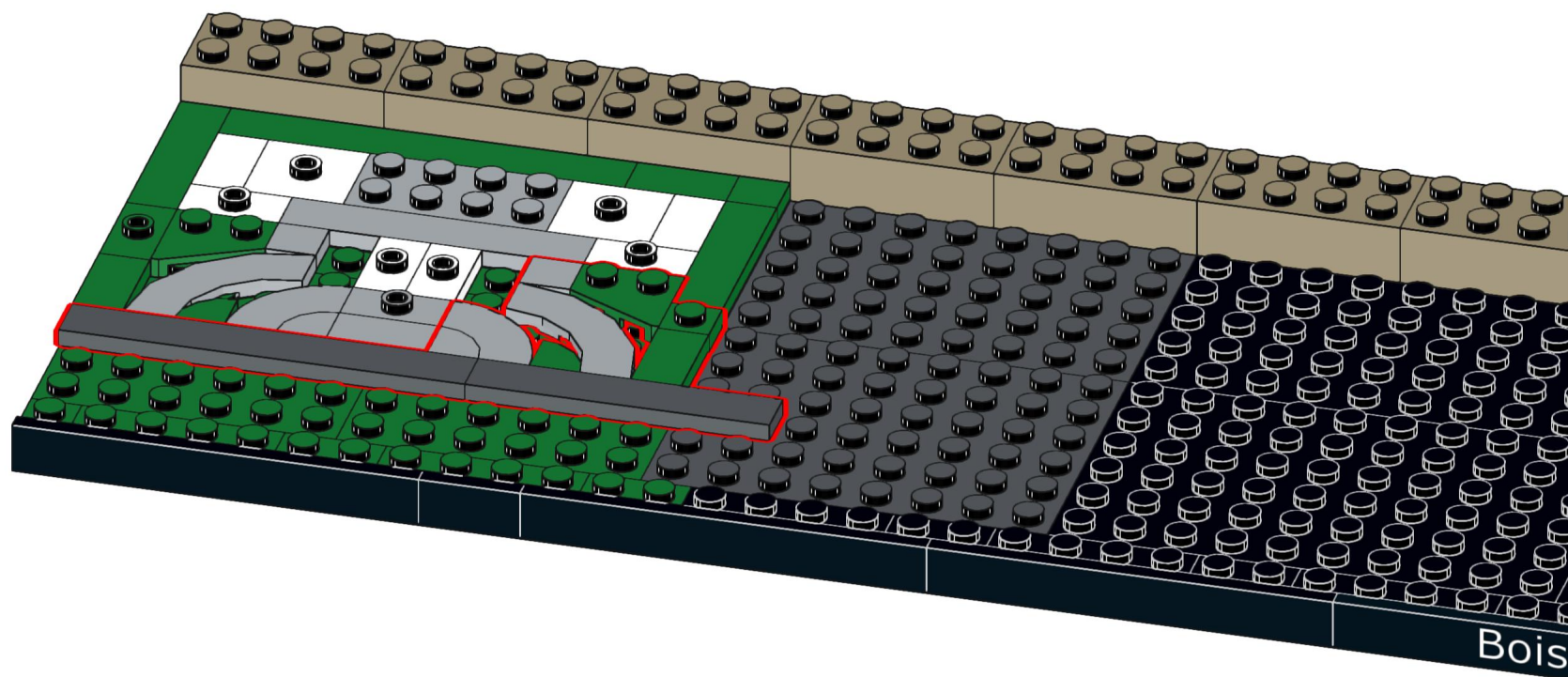
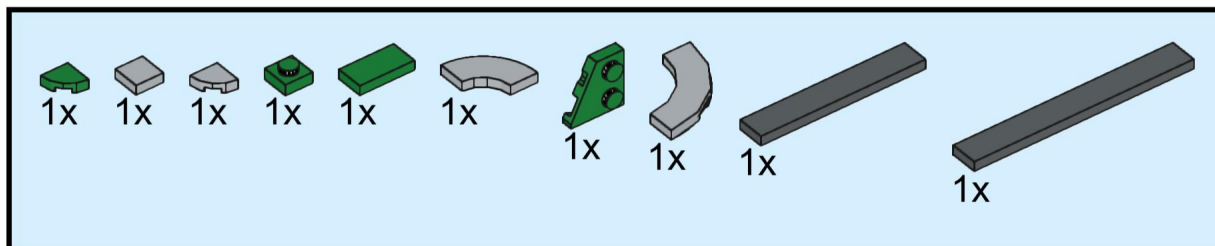

26

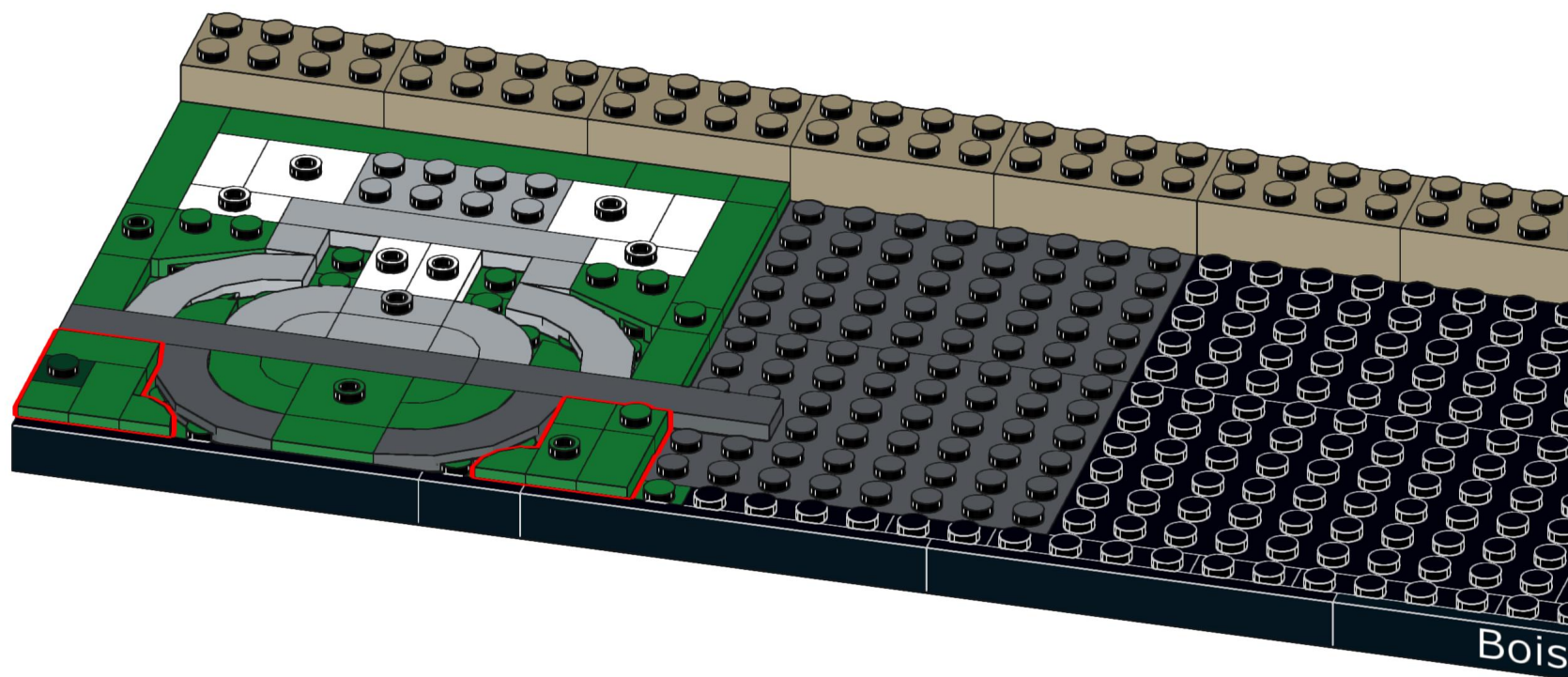
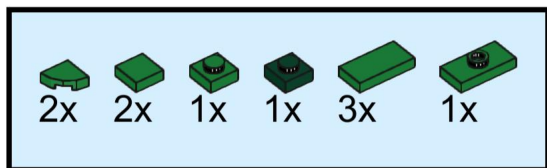

27

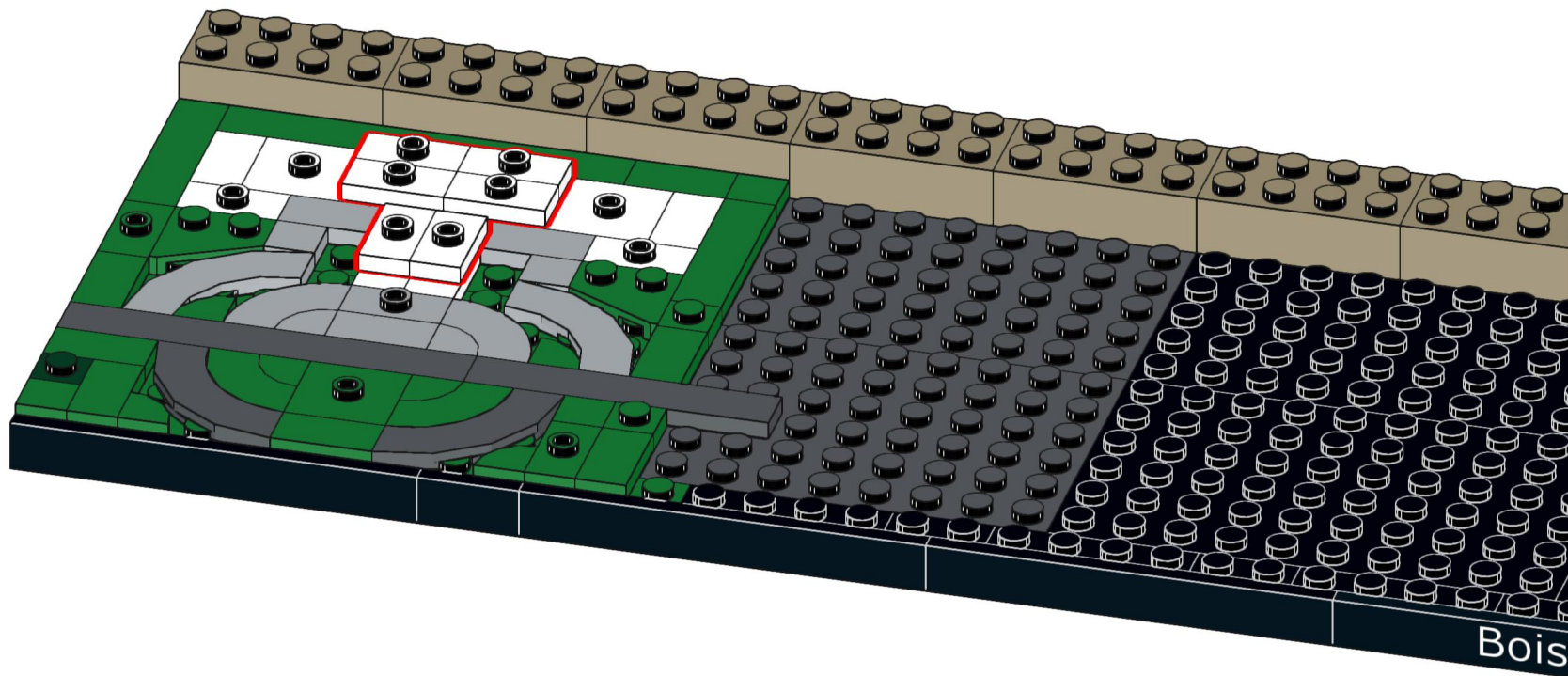
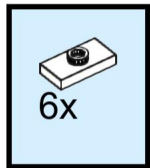

28

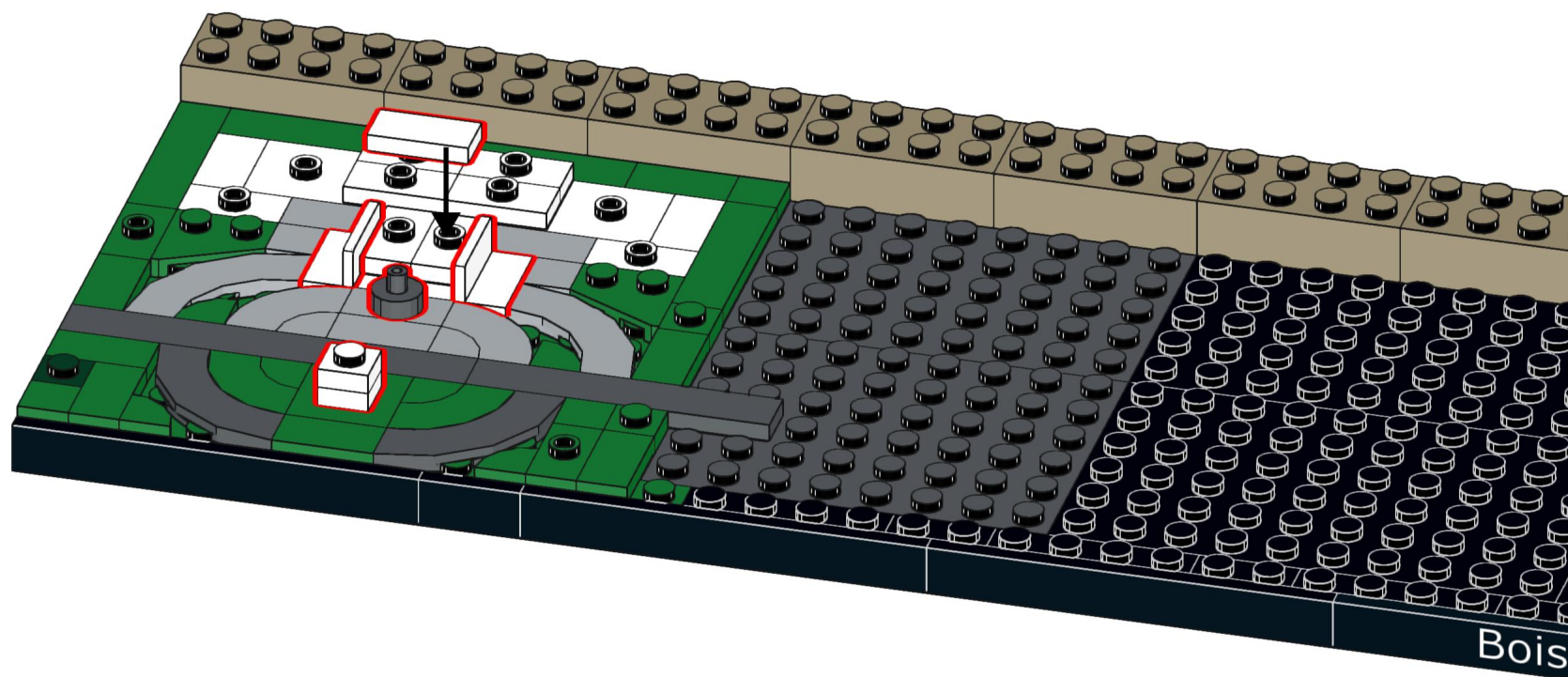
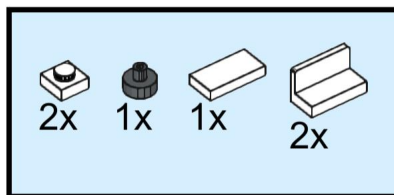

29

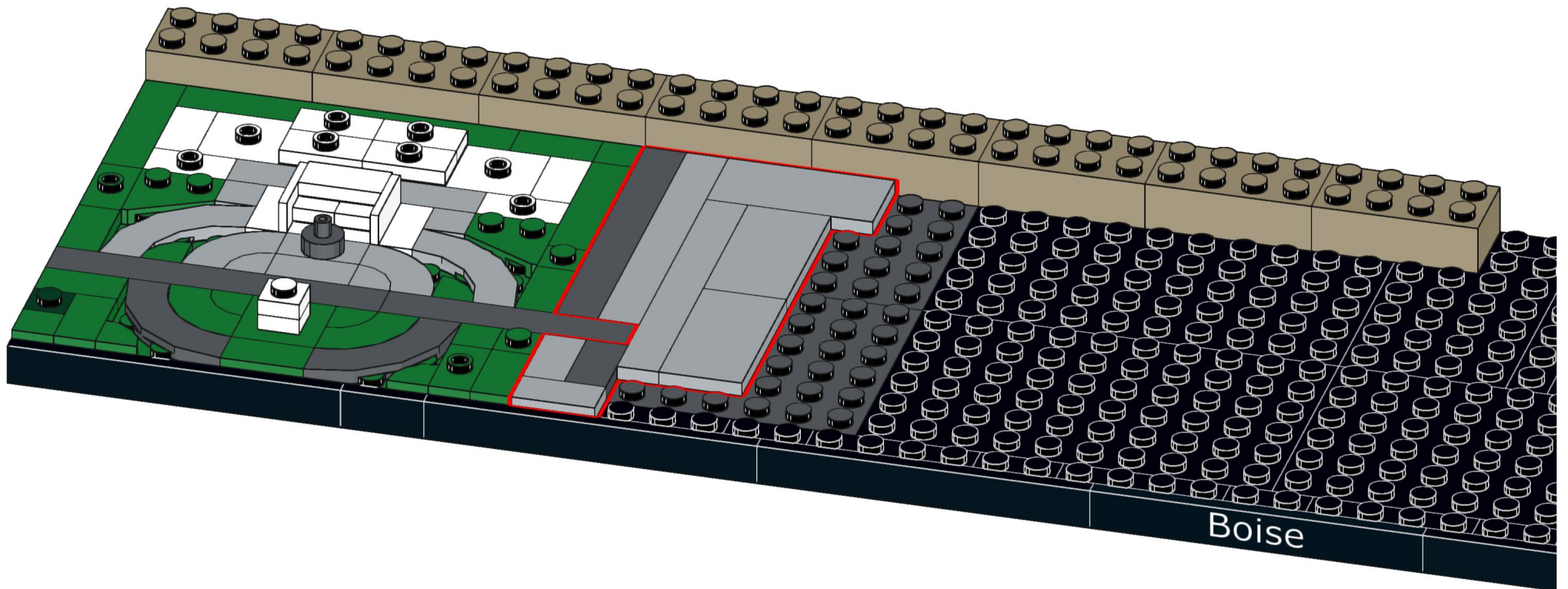
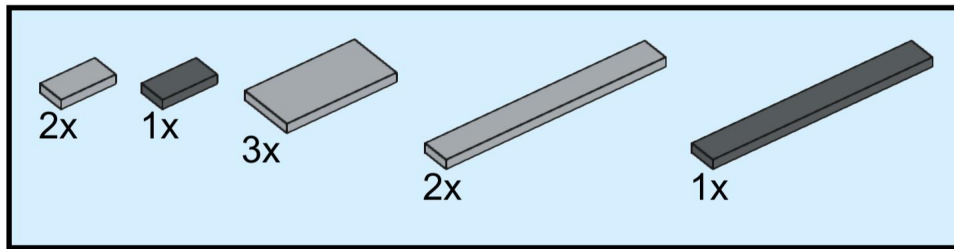

30

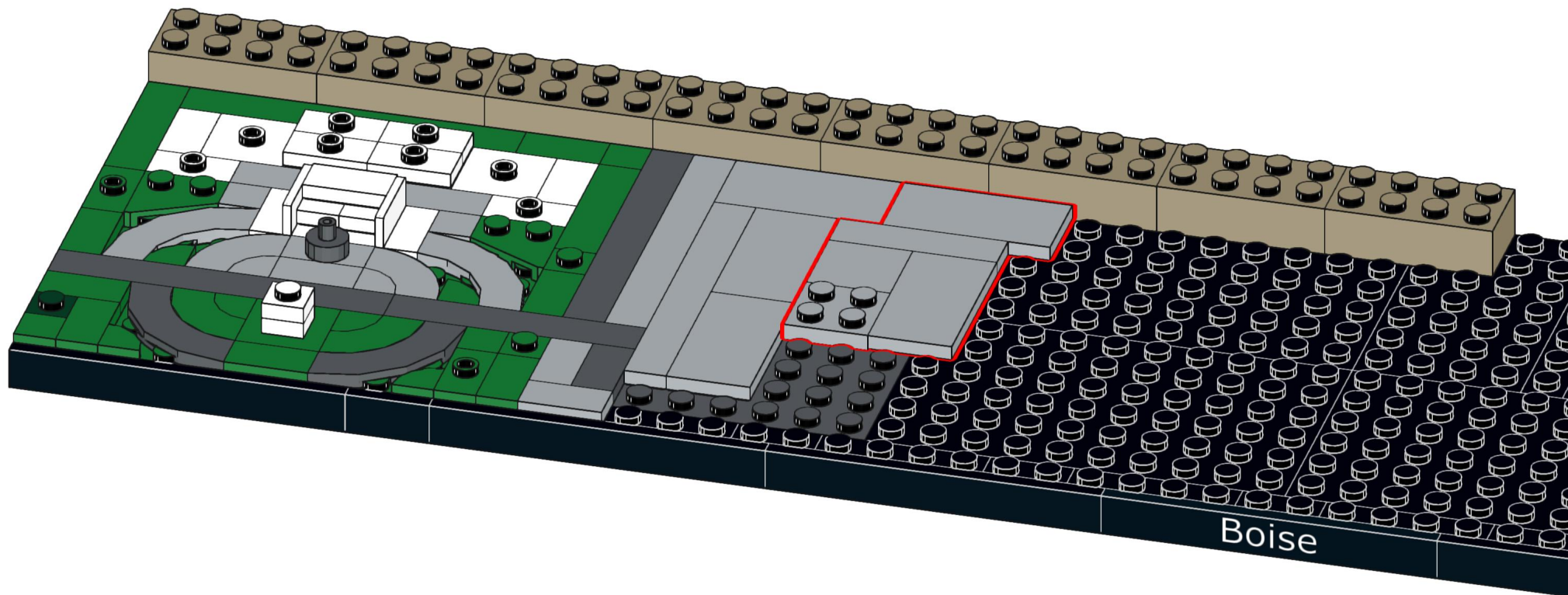
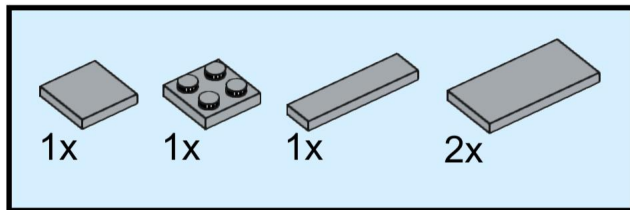

31

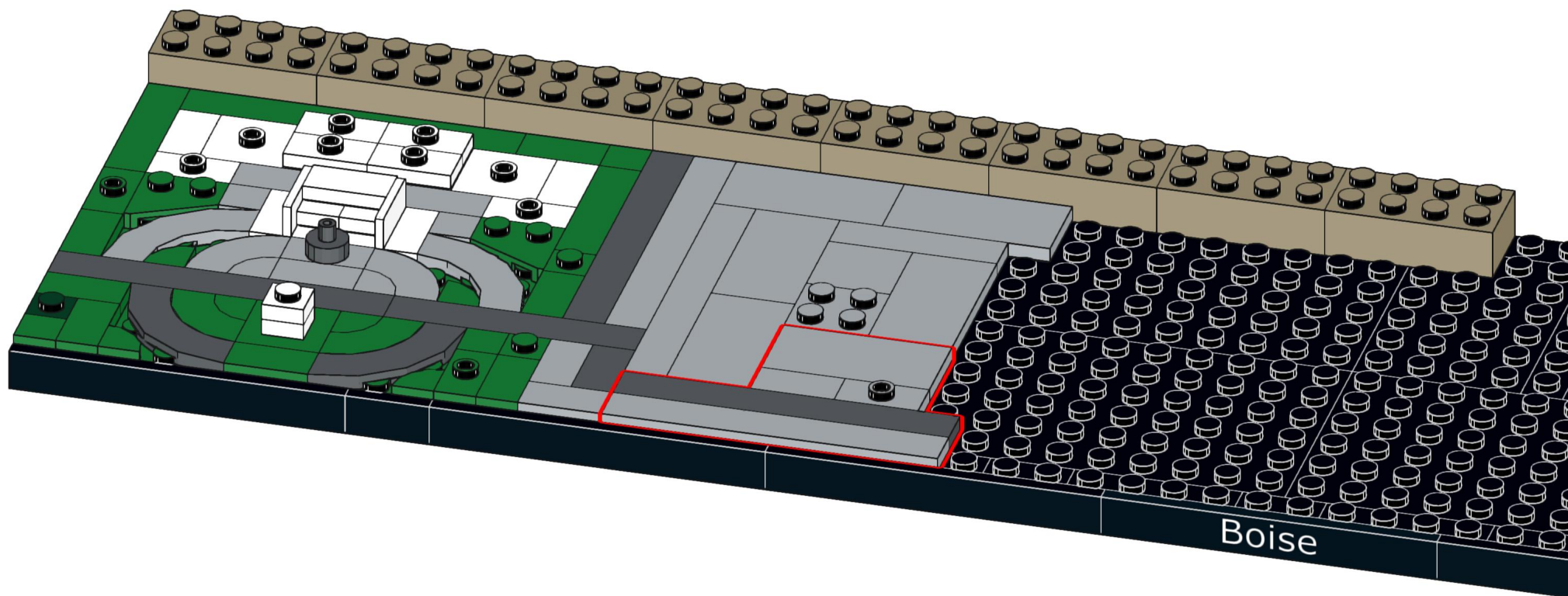
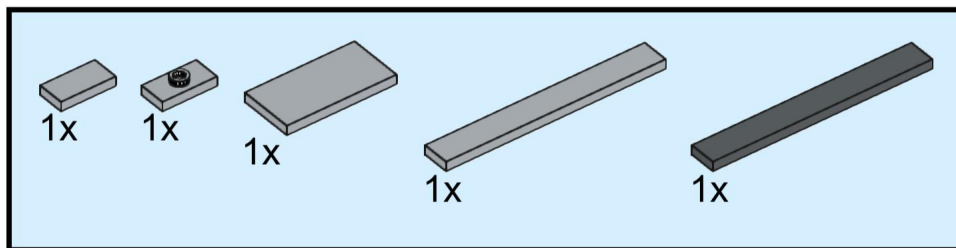

32

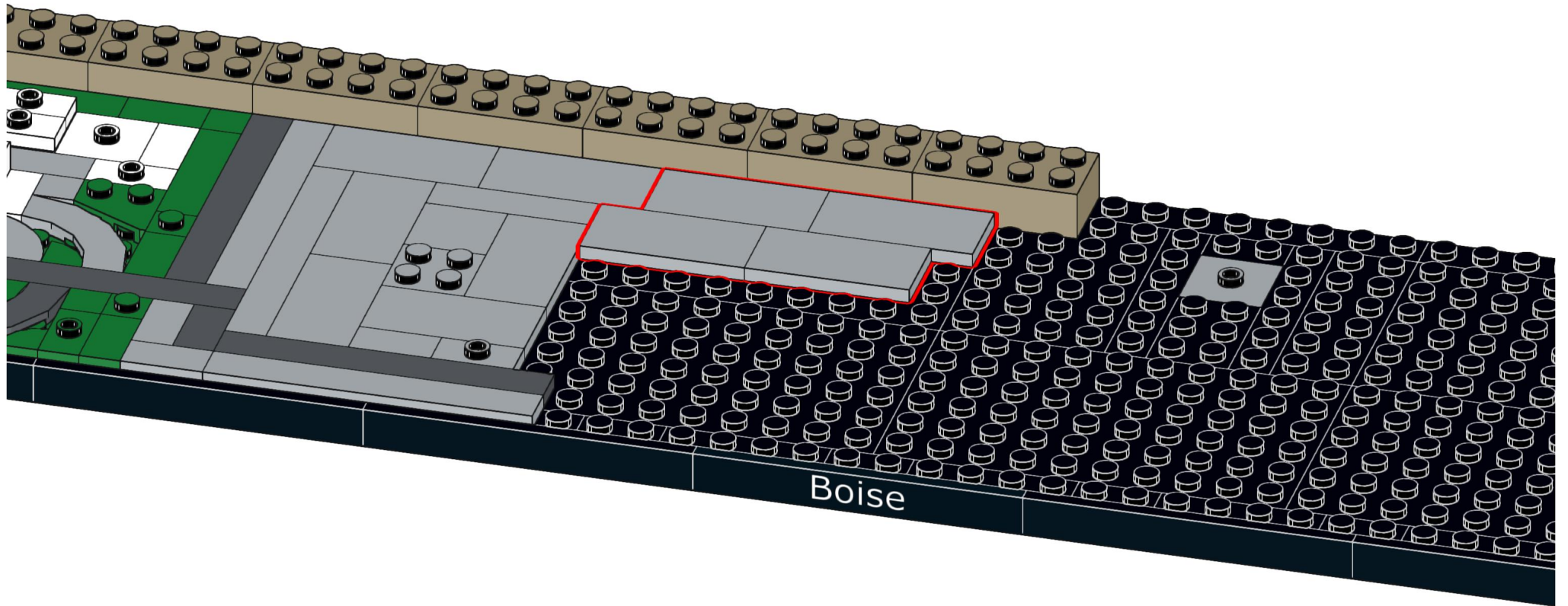
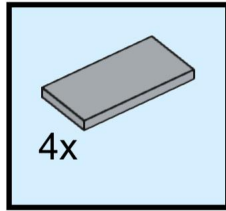

33

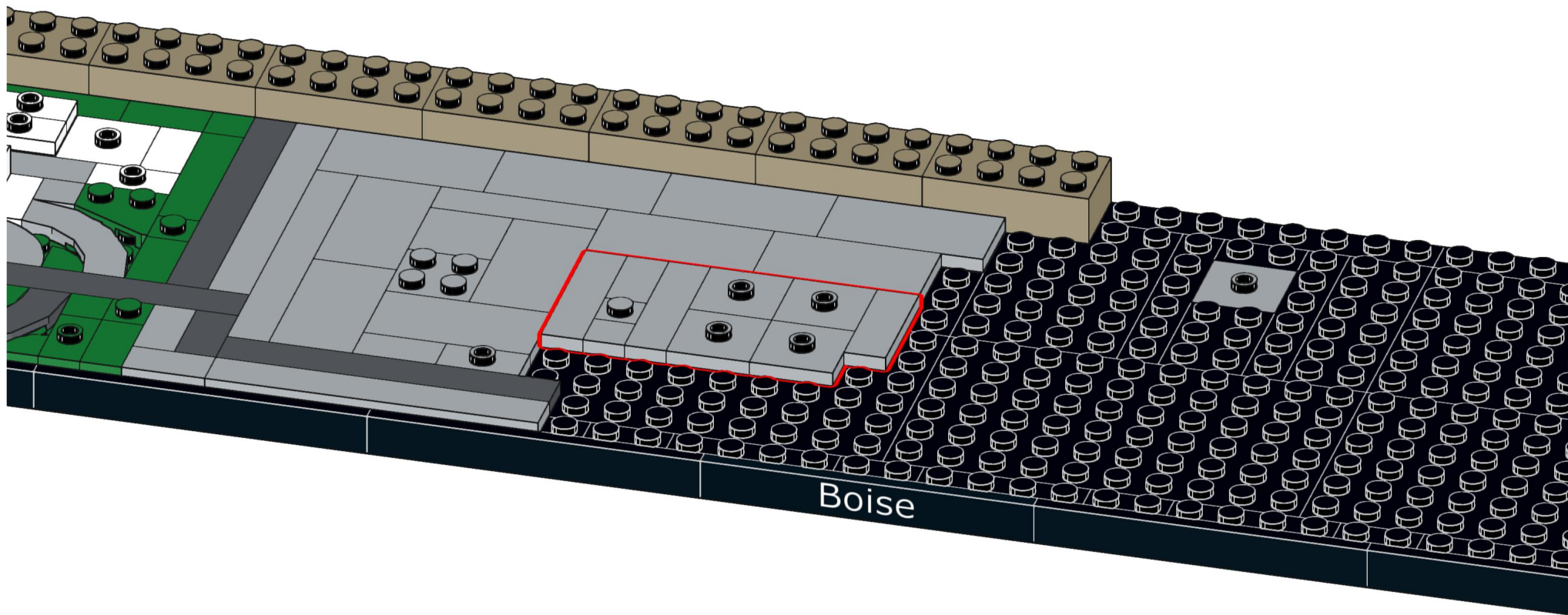
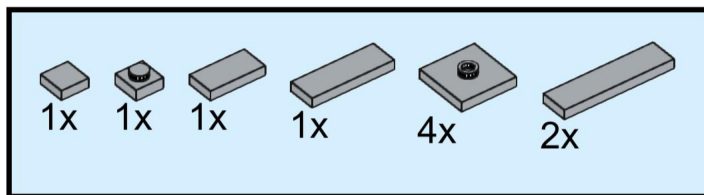

34

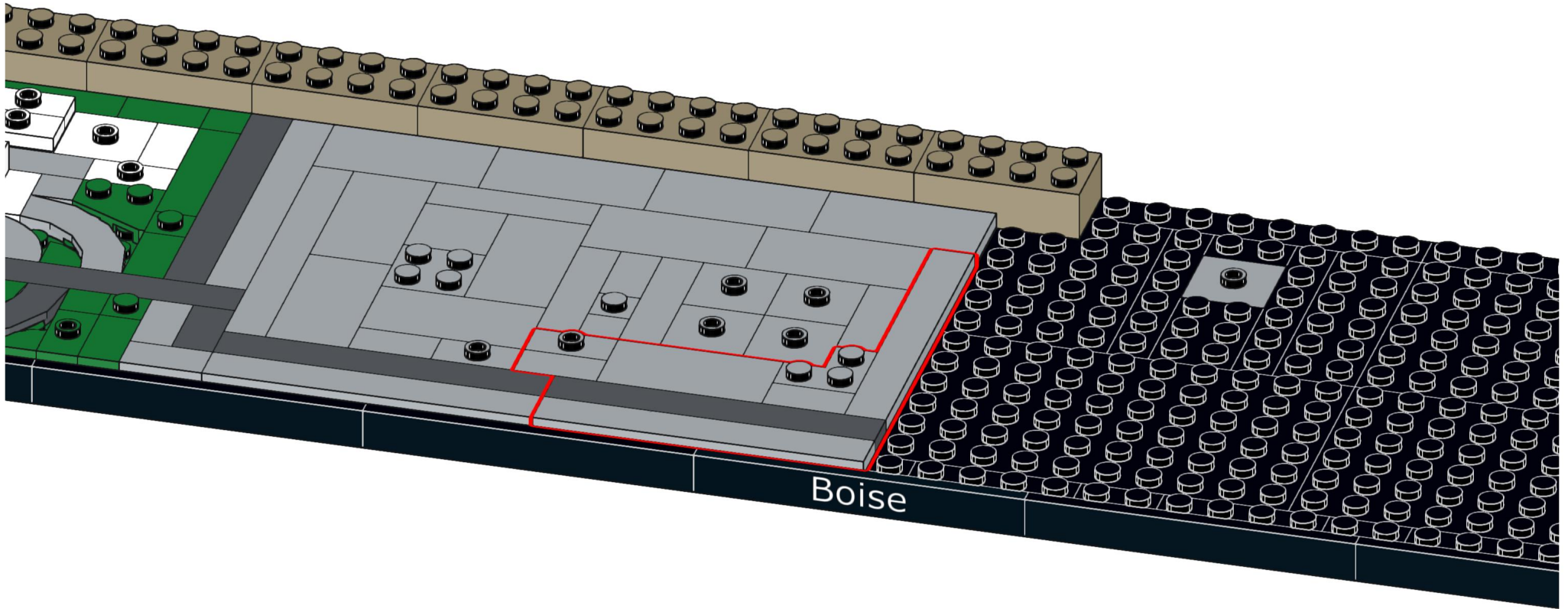
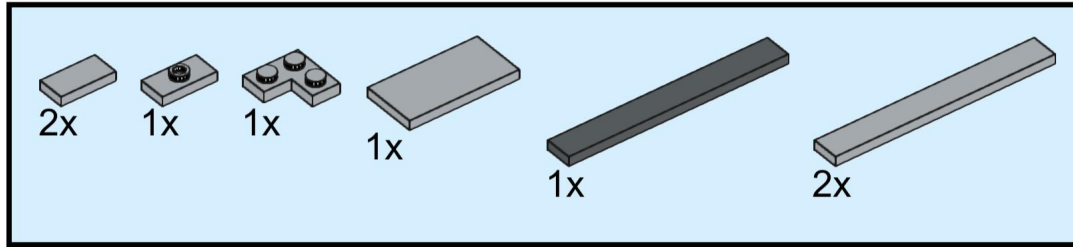

35

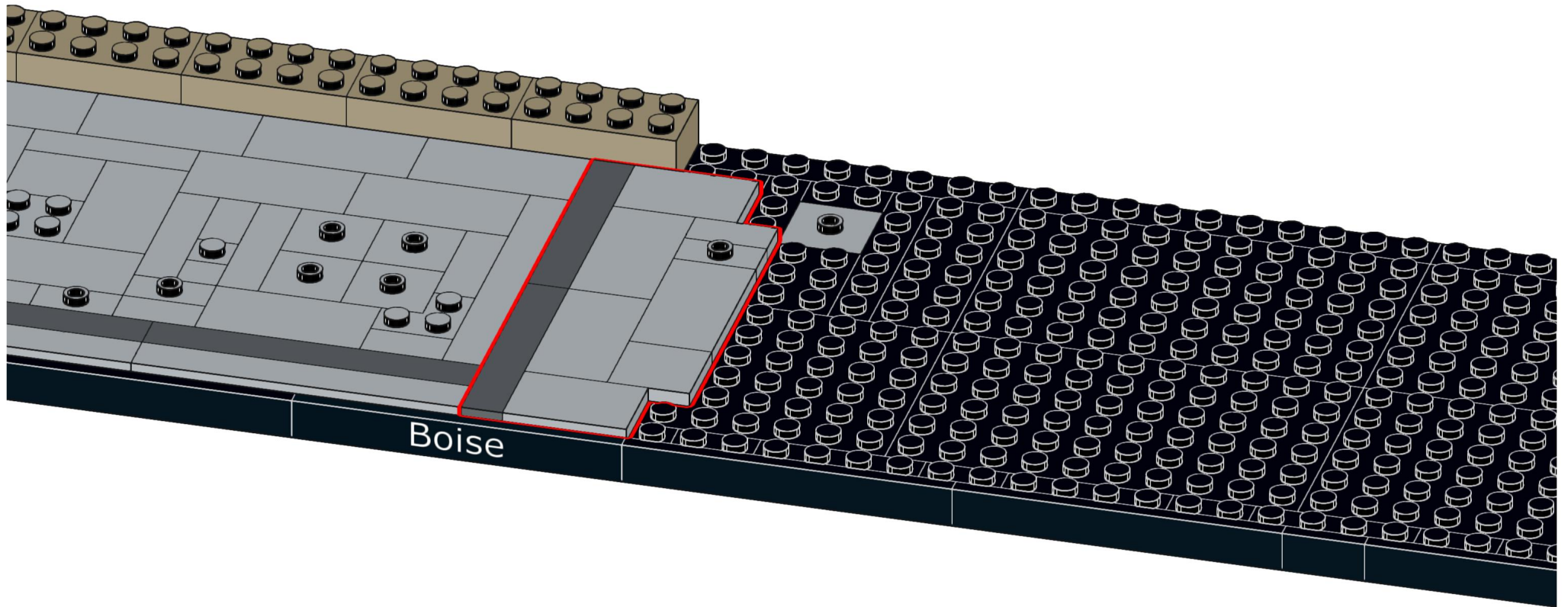
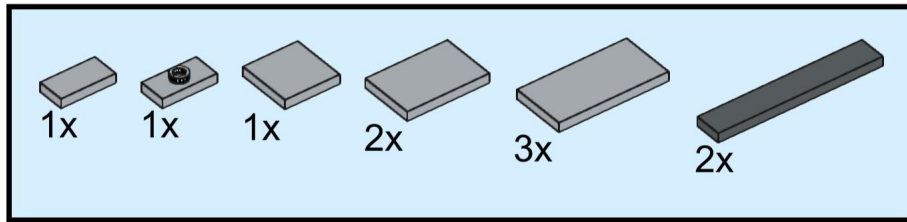

37

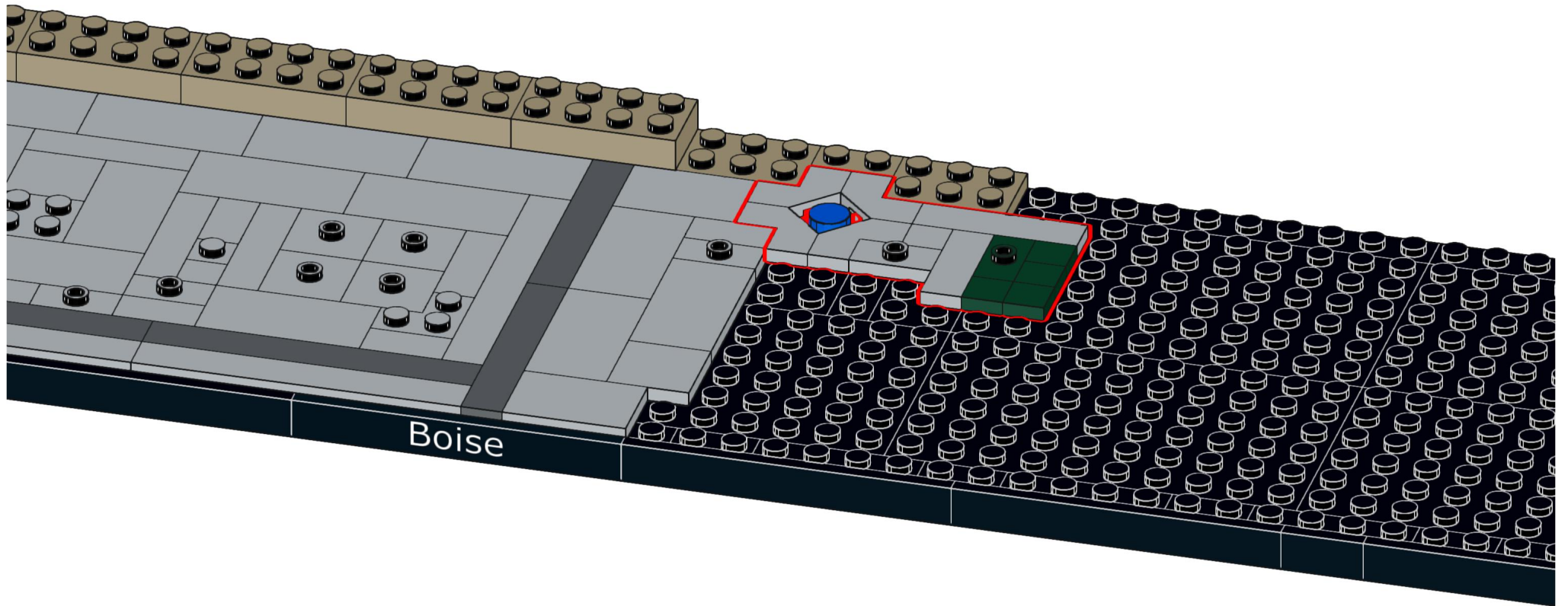
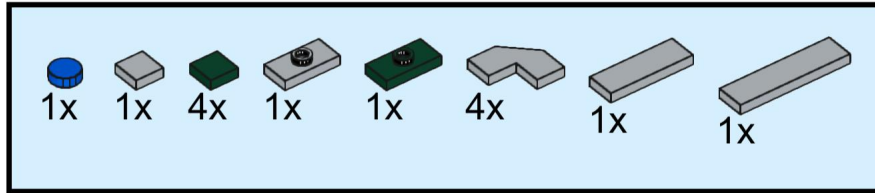

38

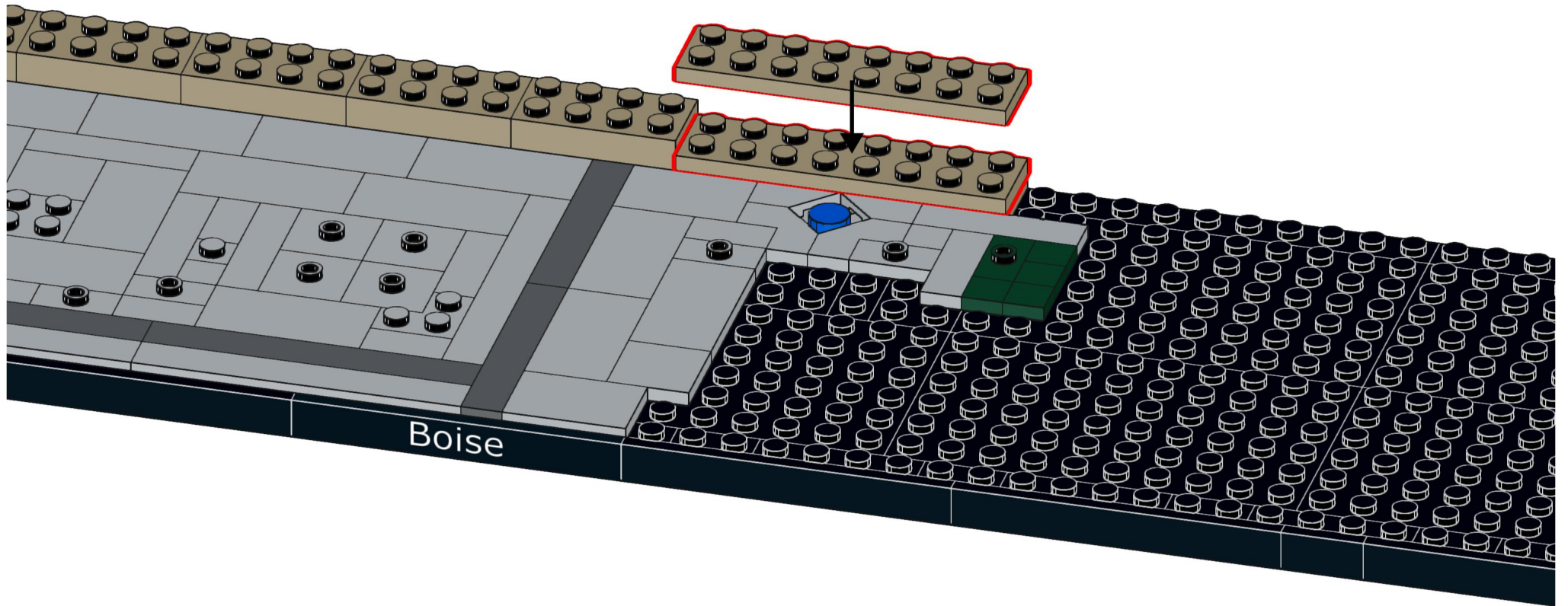
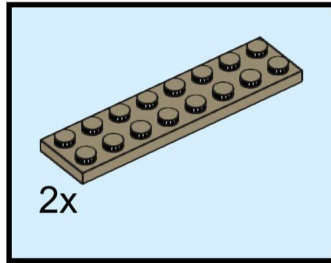

39

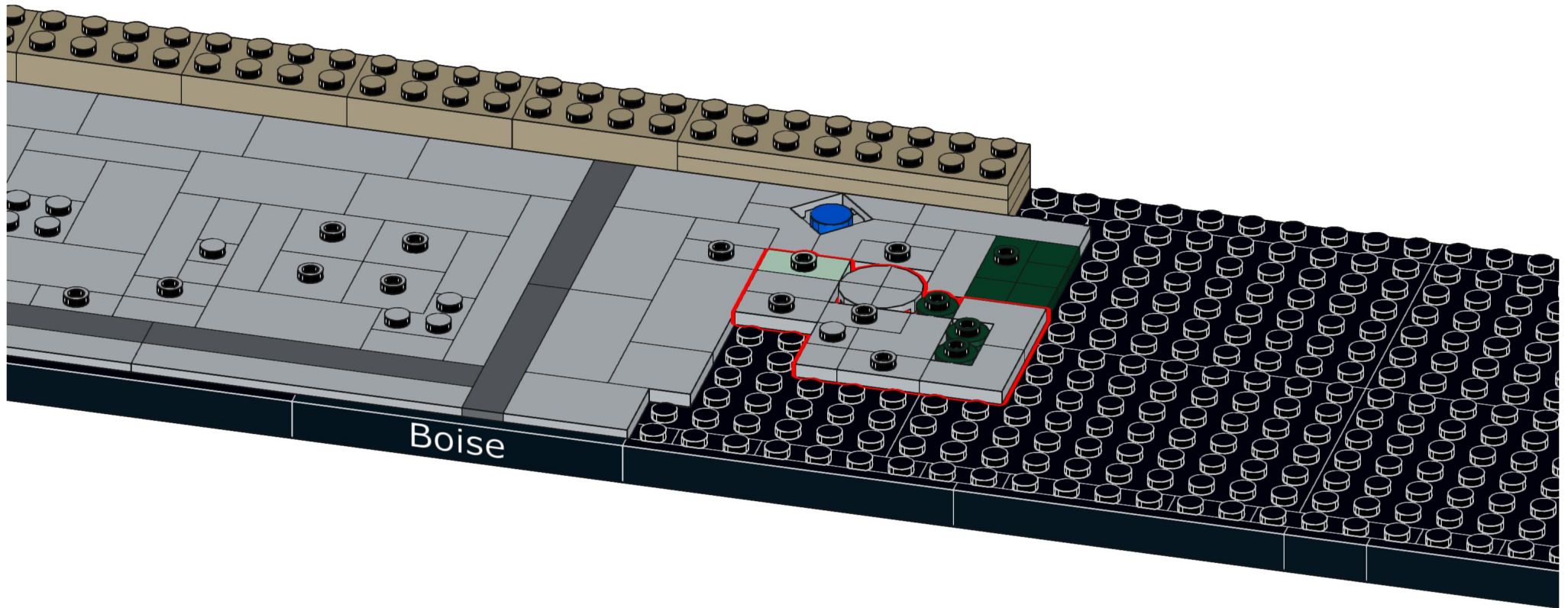
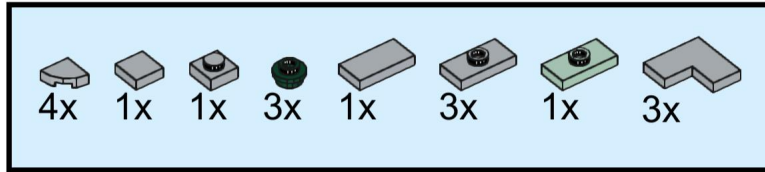

40

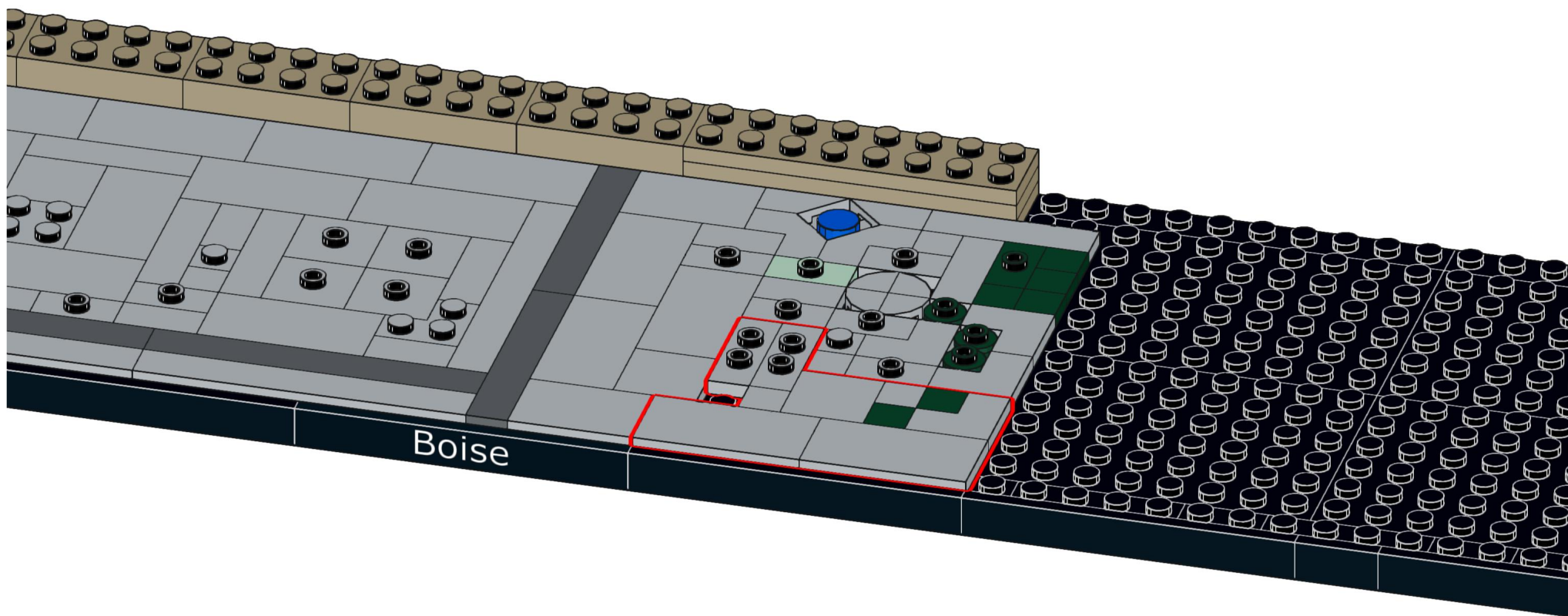
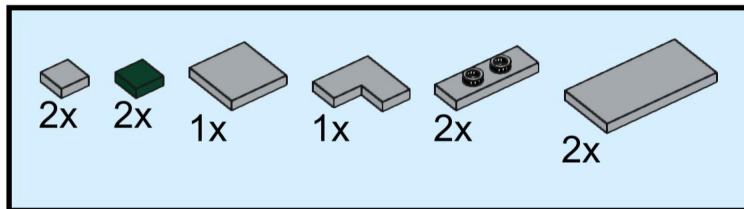

41

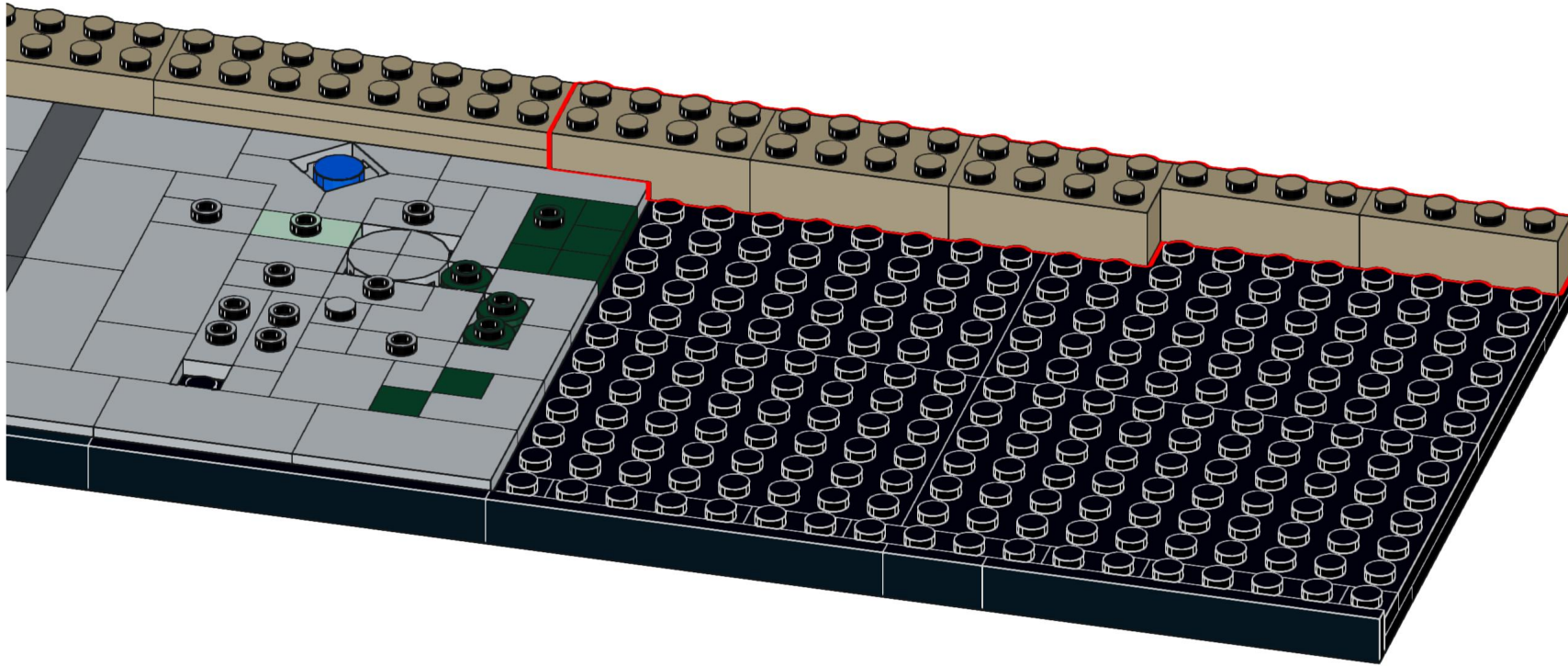
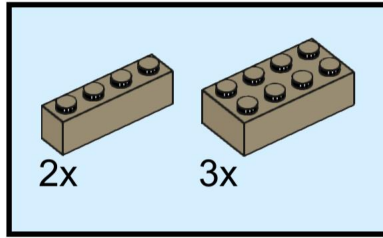

42

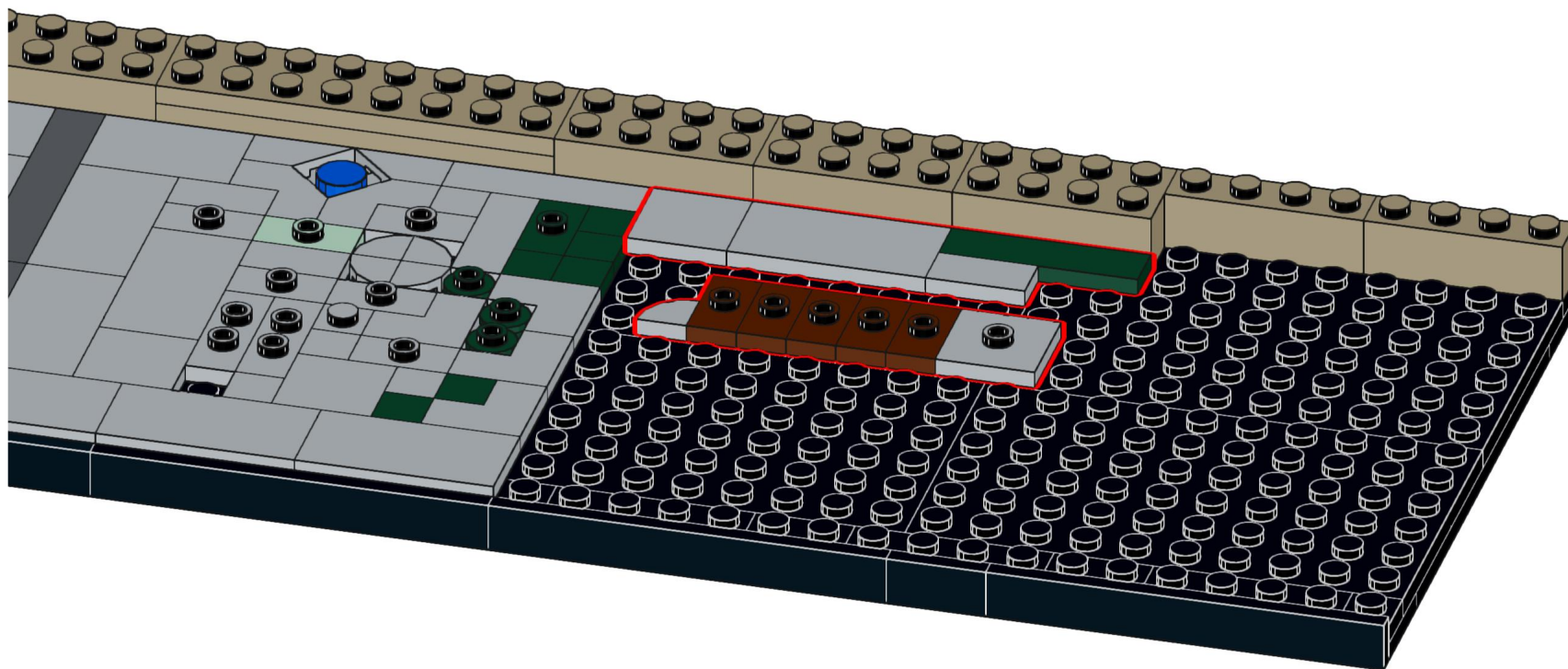
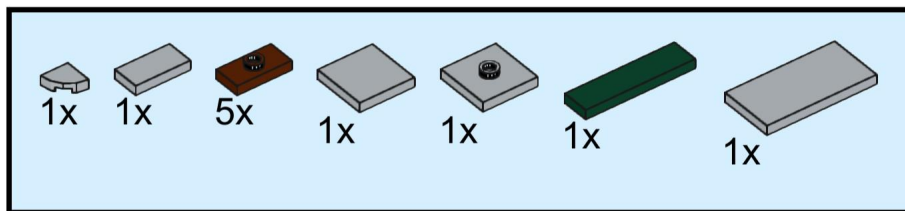

43

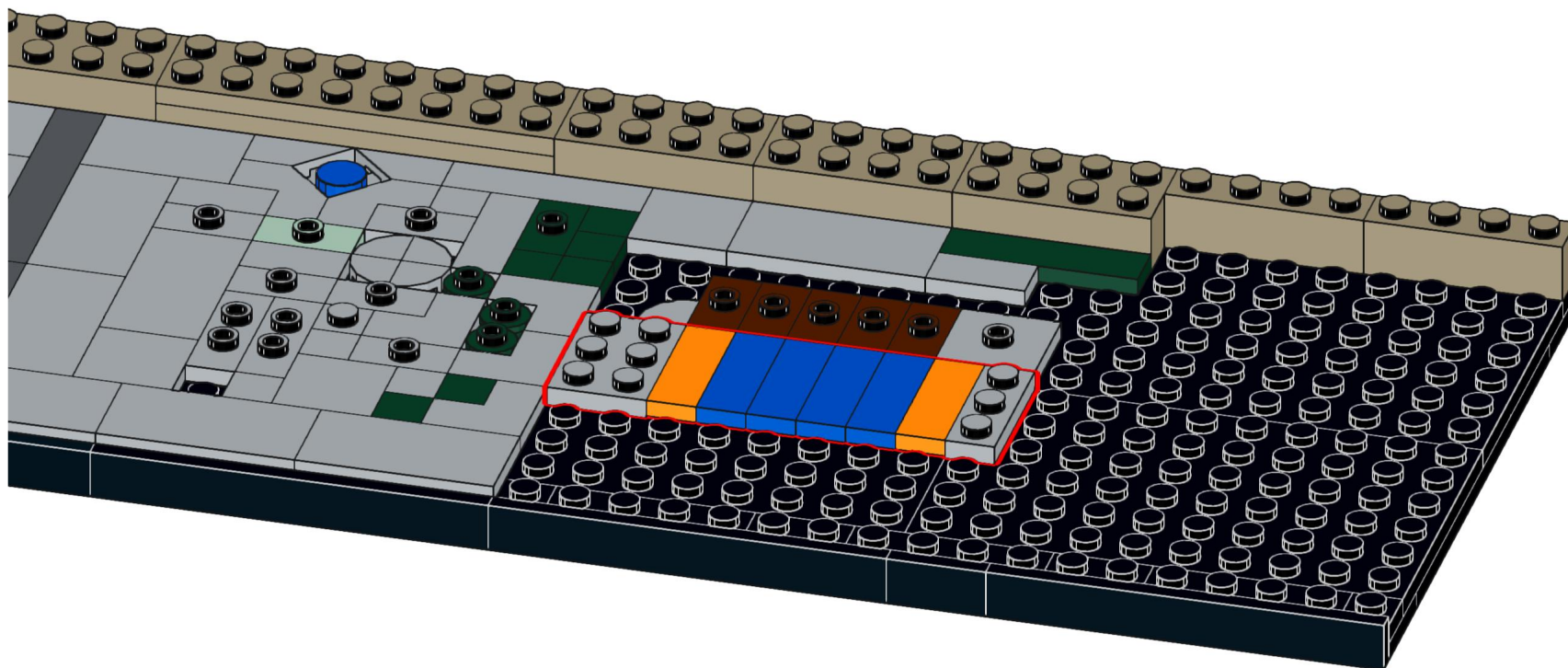
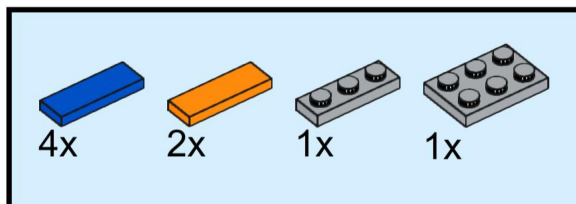

44

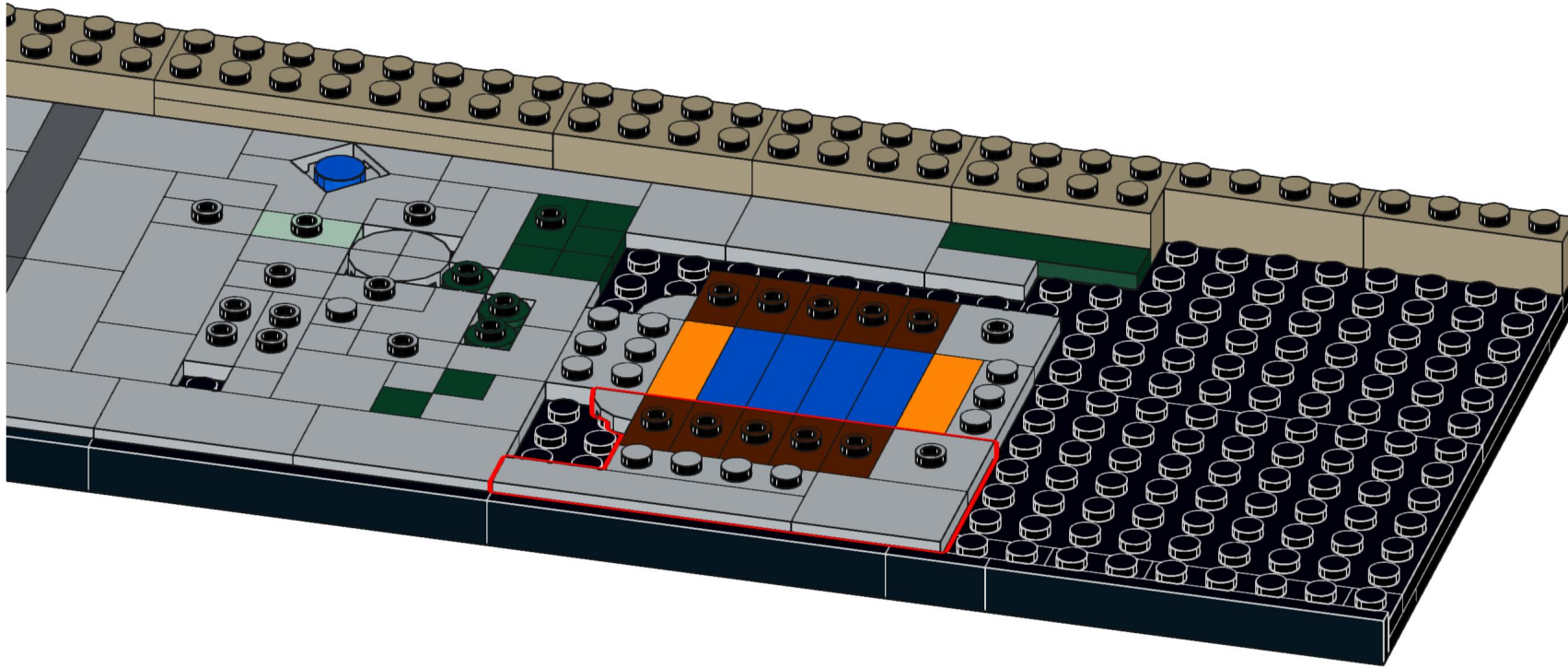
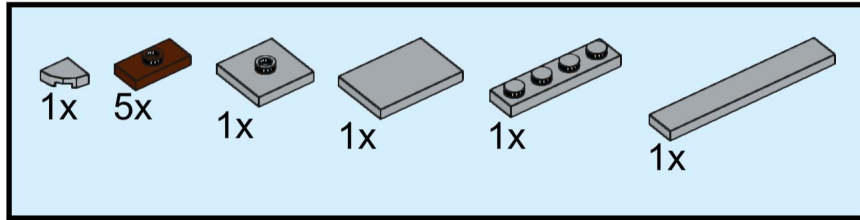

45

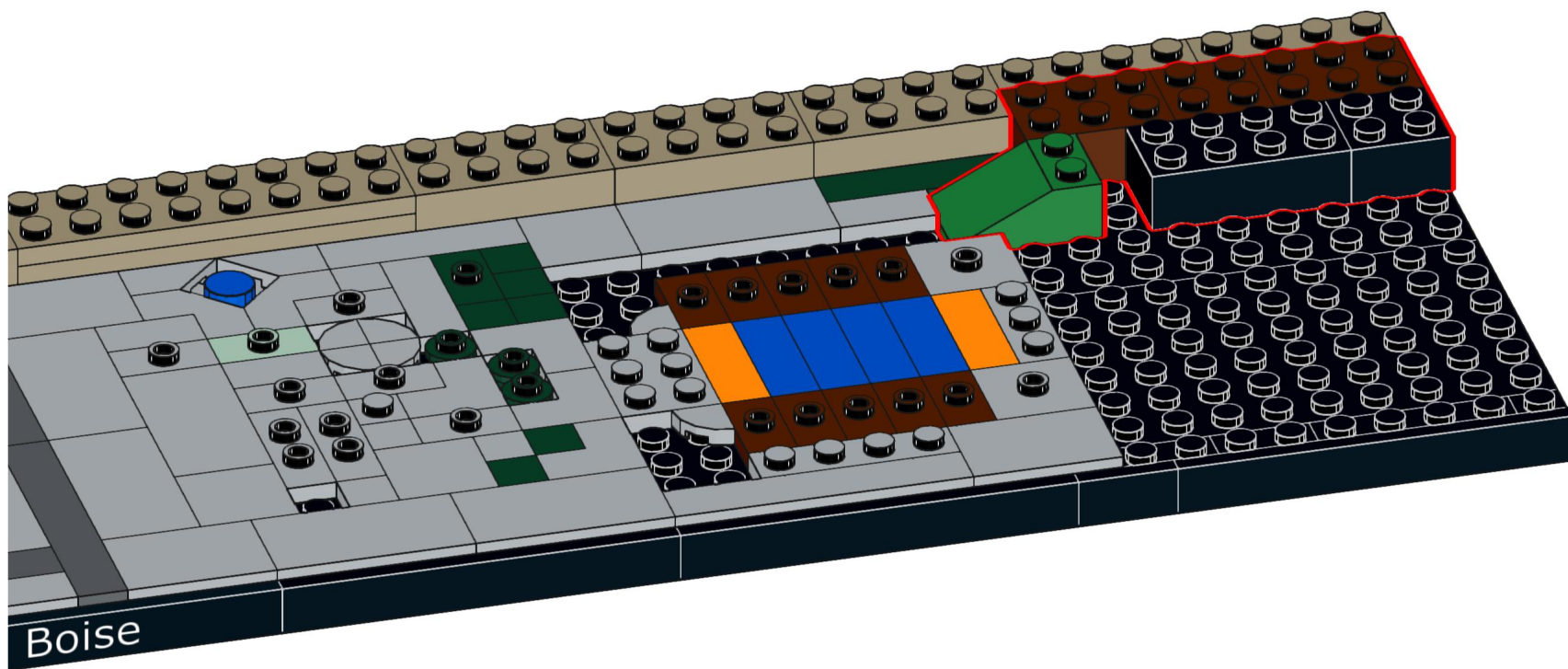
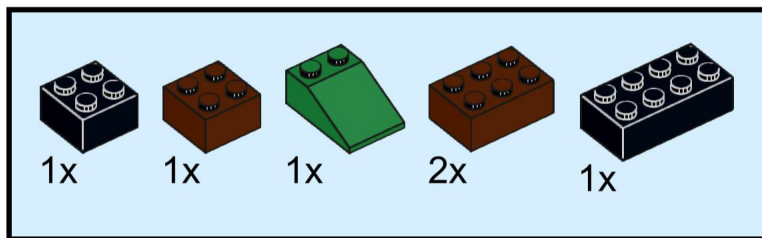

46

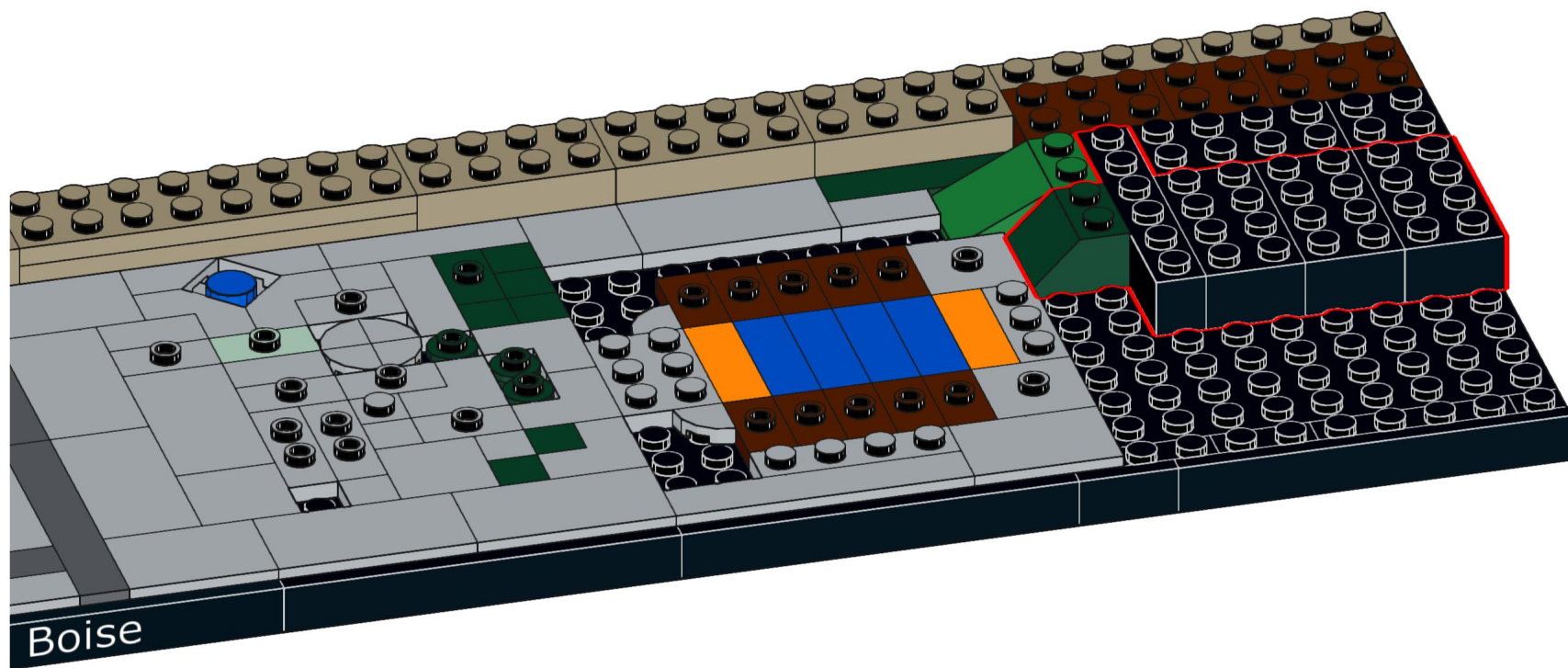
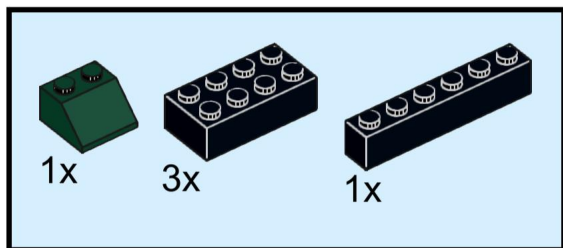

47

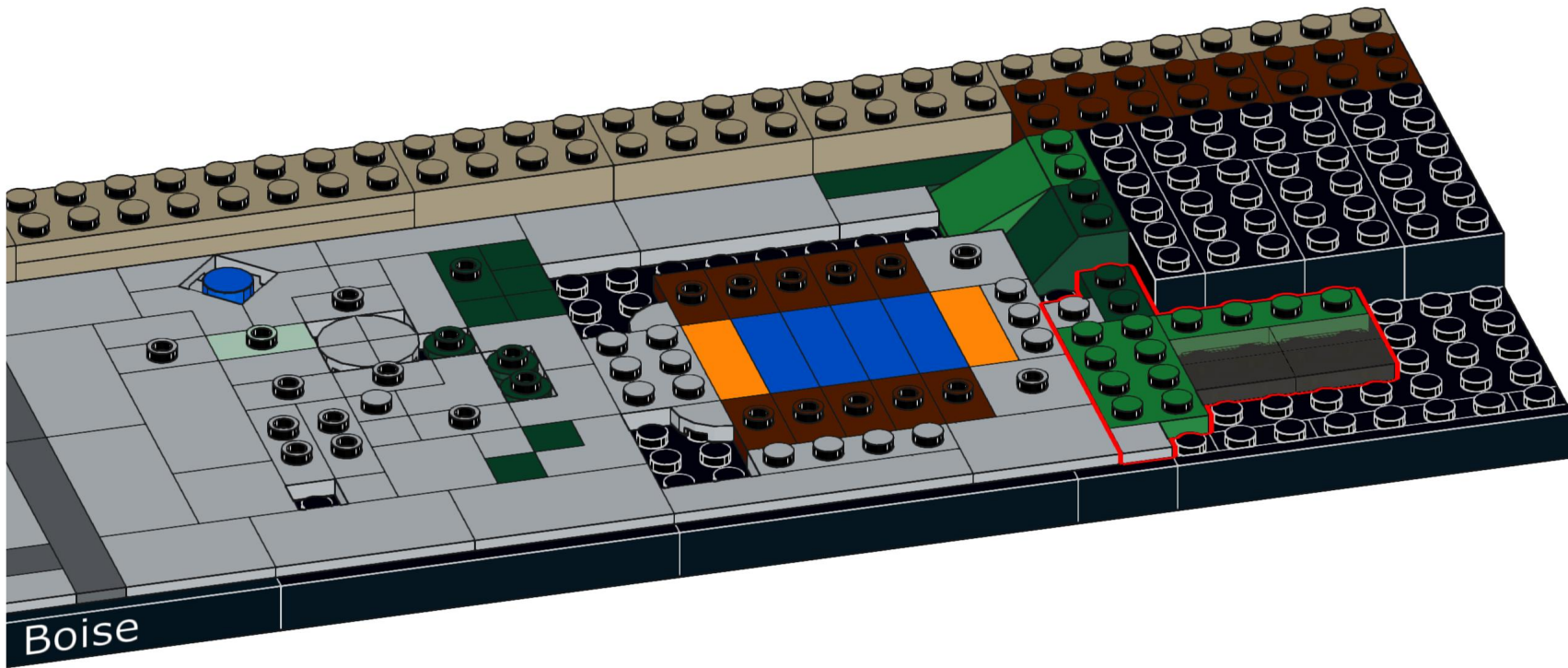
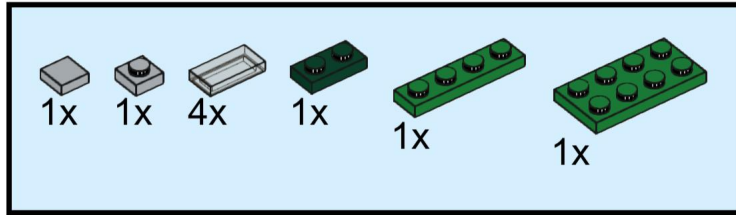

48

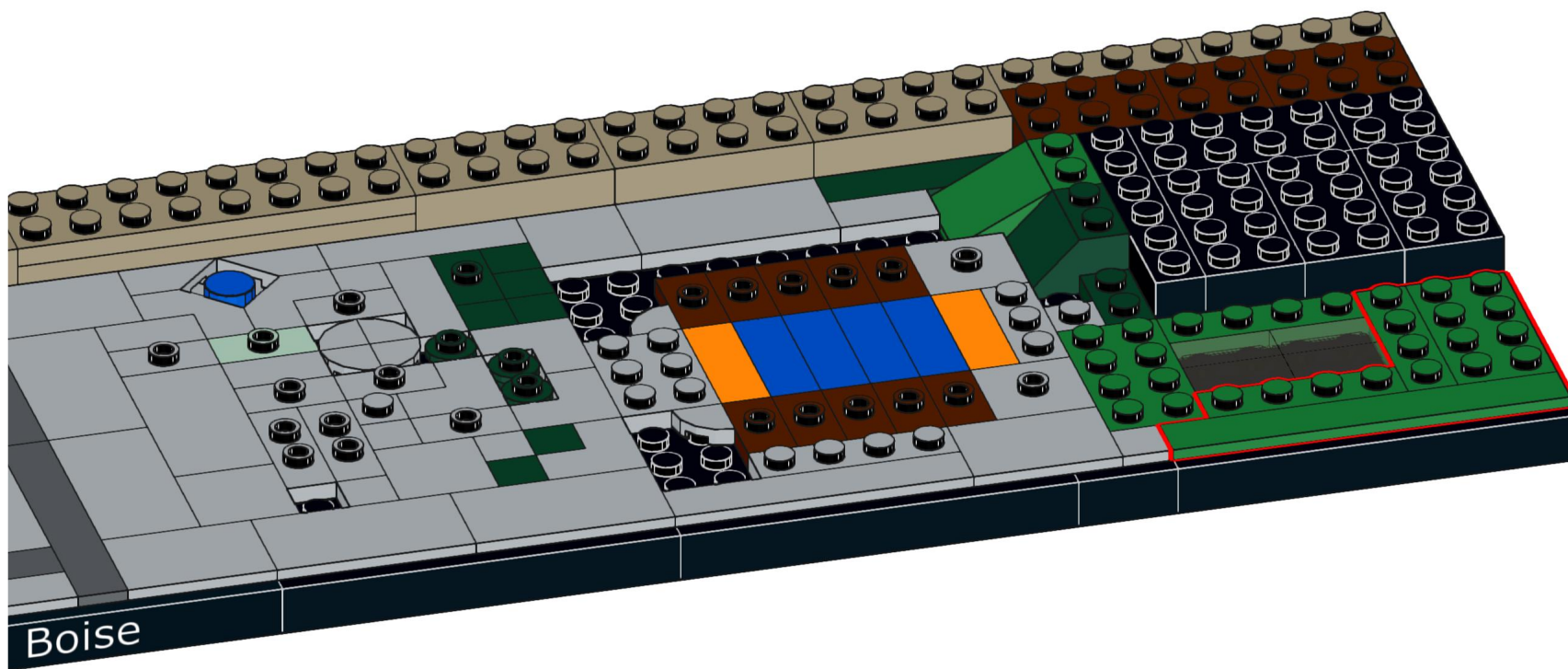
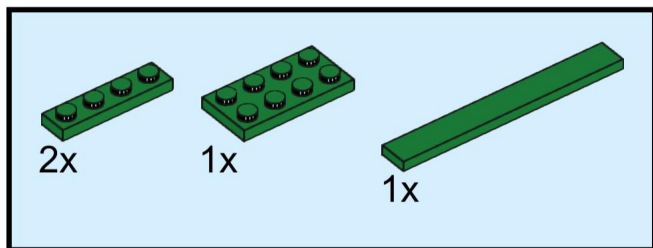

49

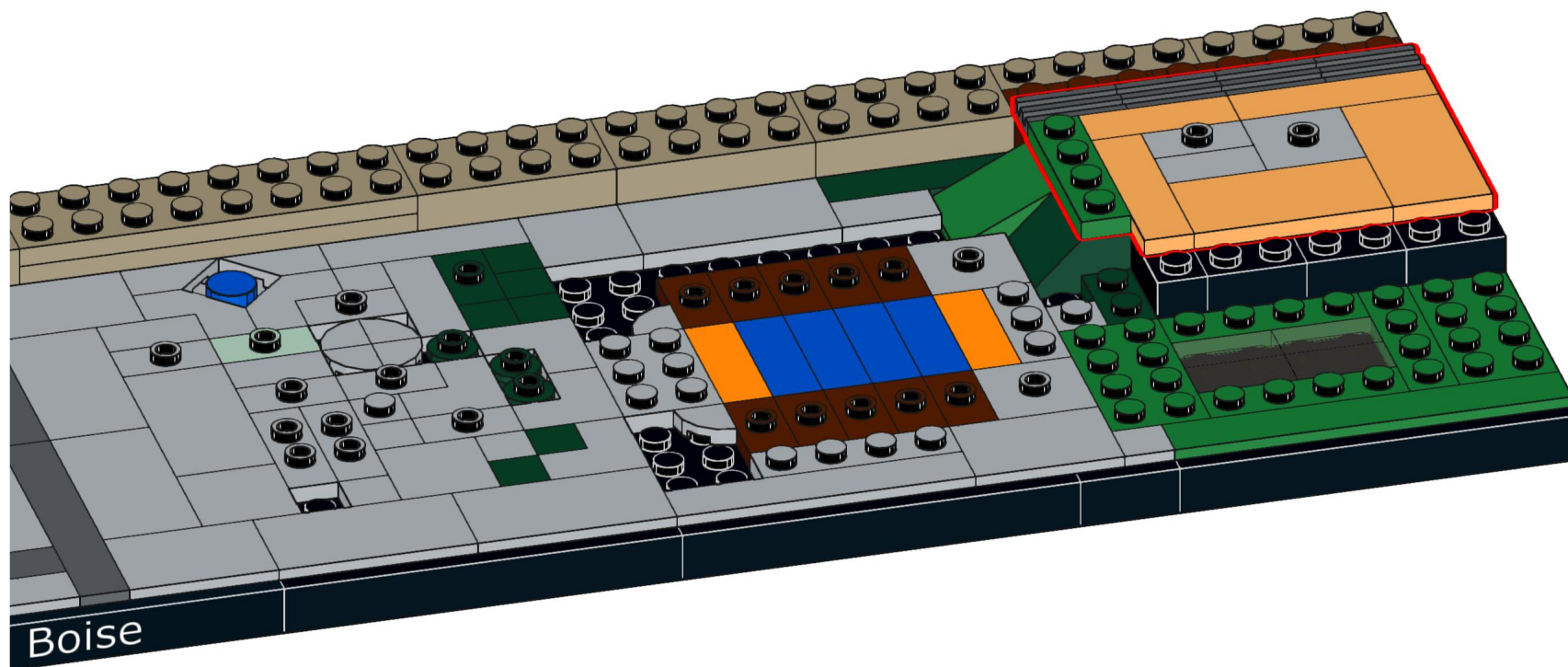
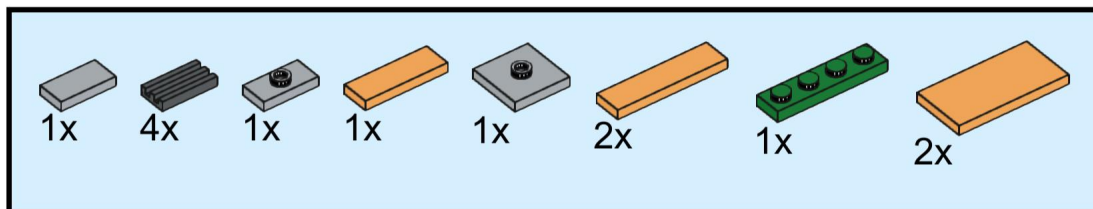

50

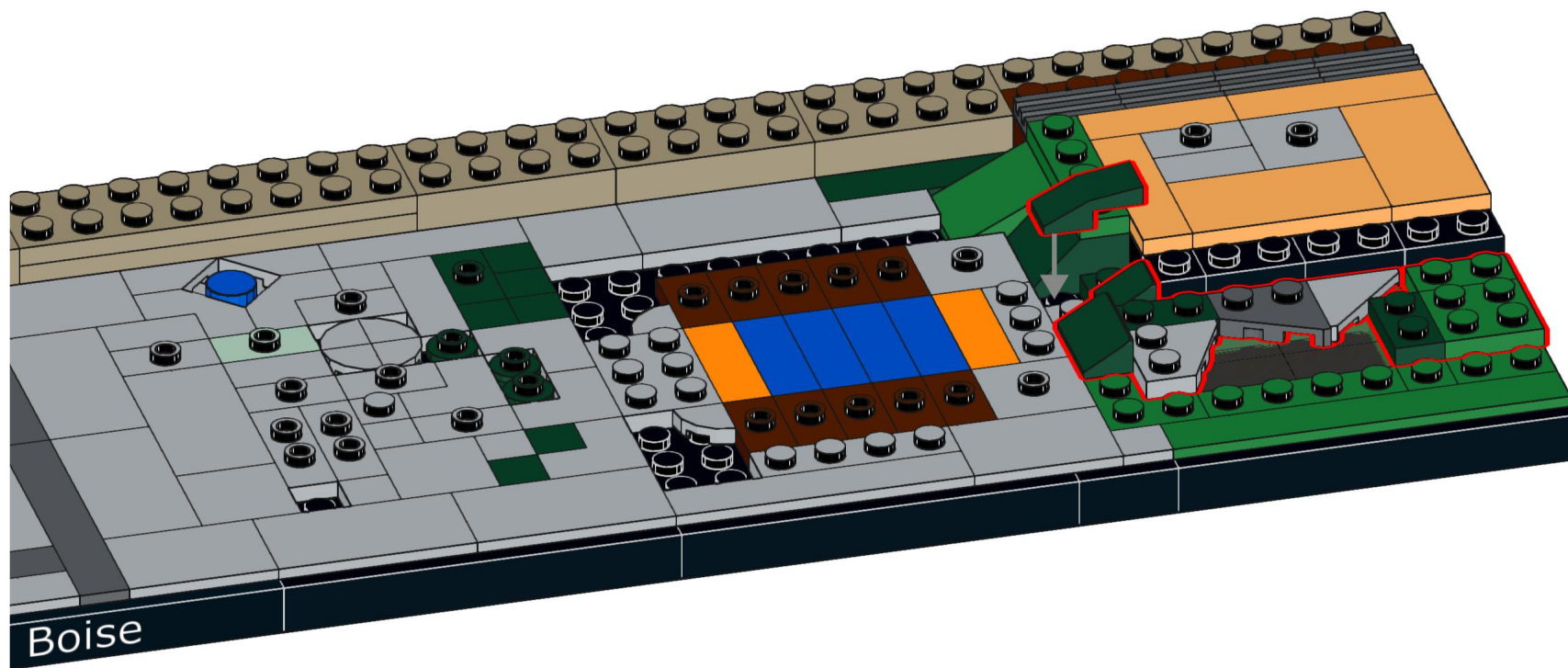
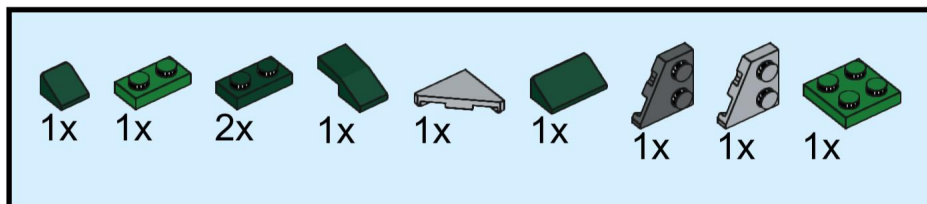

51

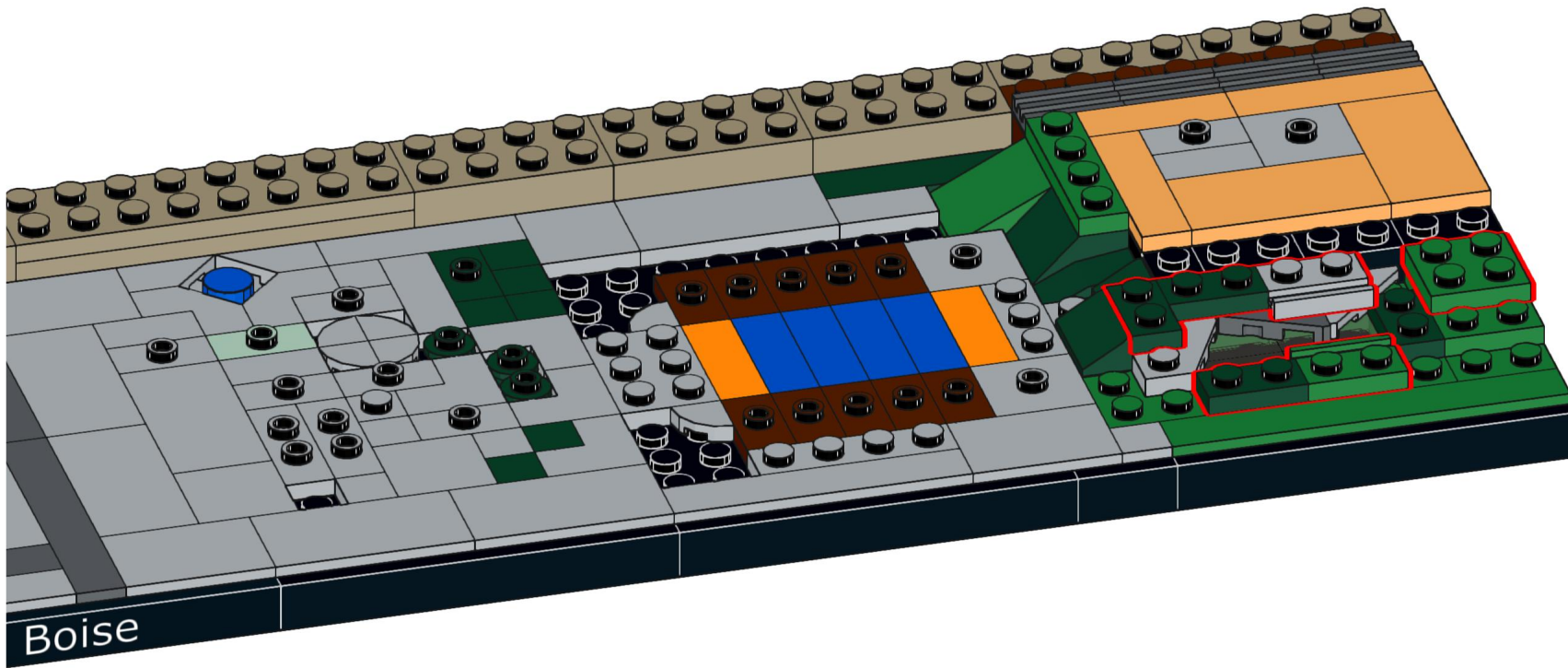
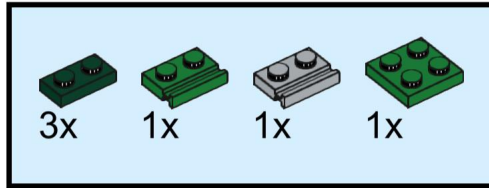

52

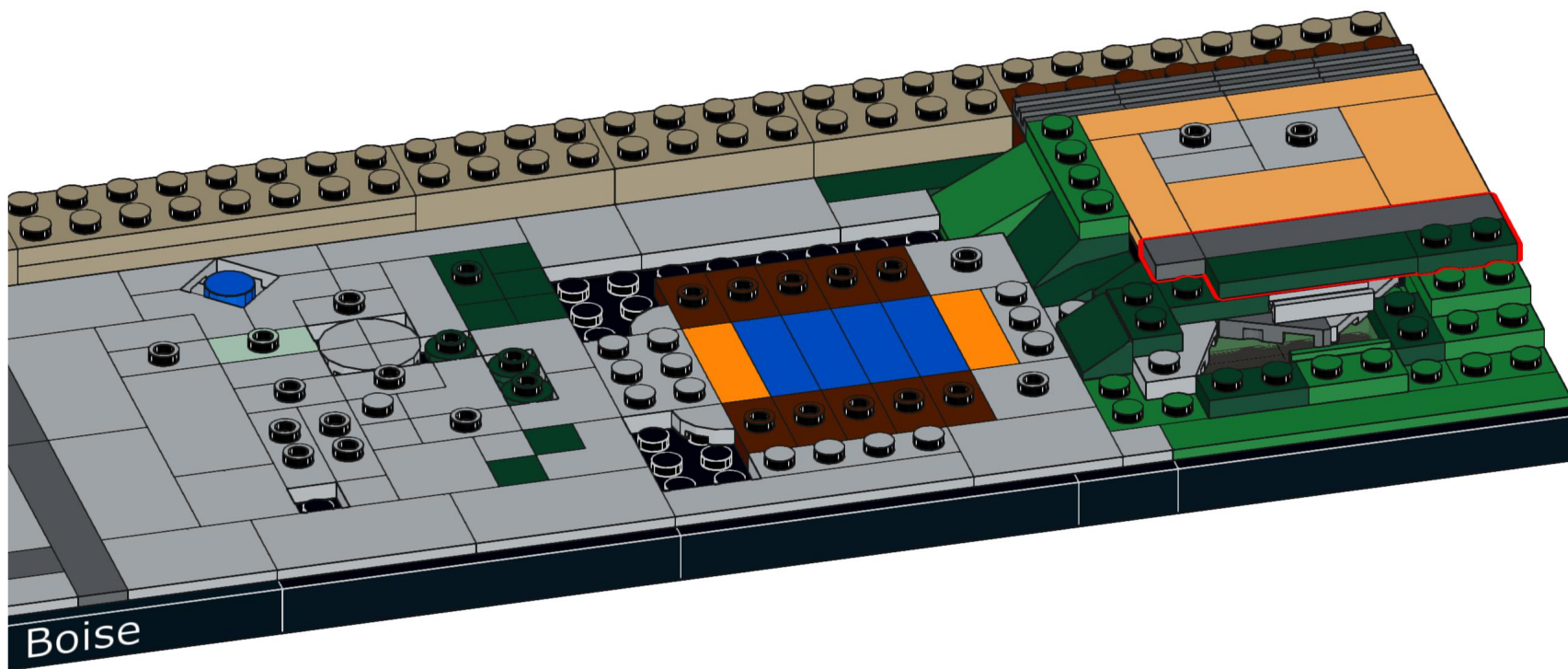
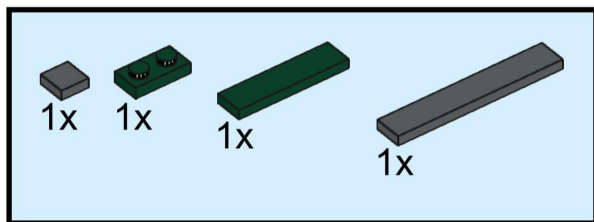

53

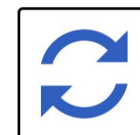
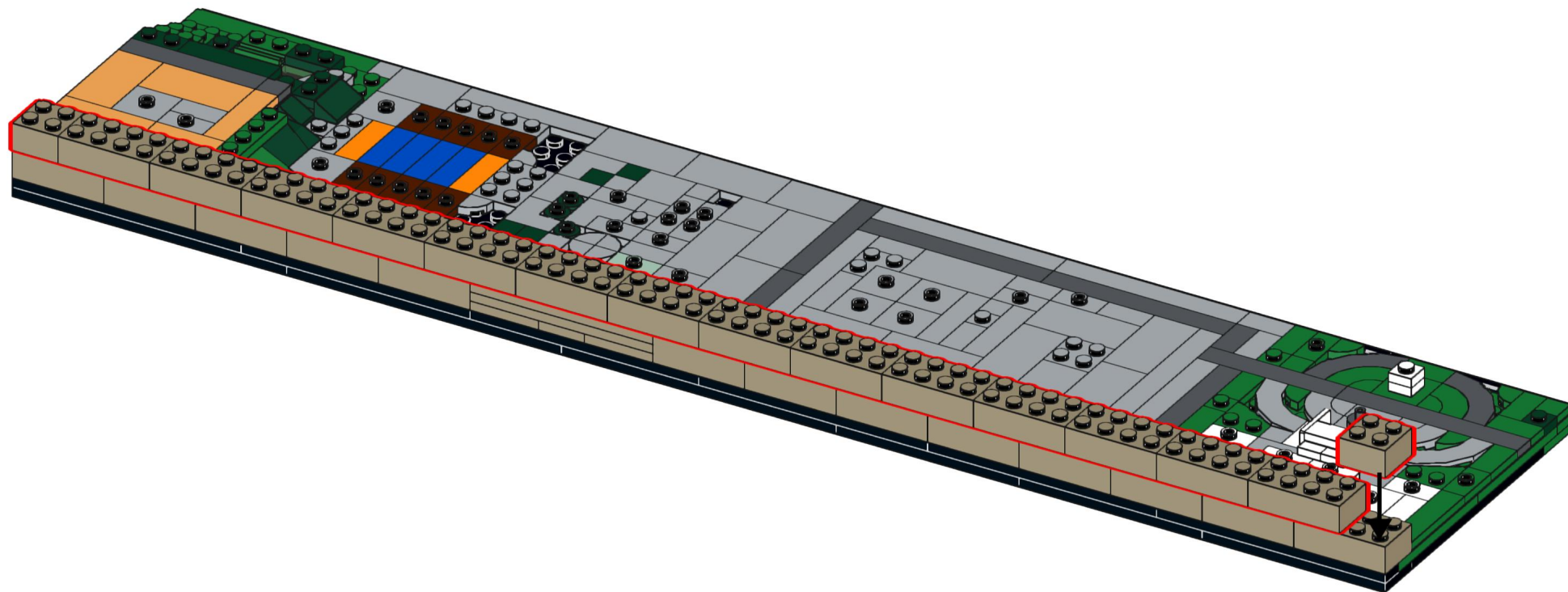
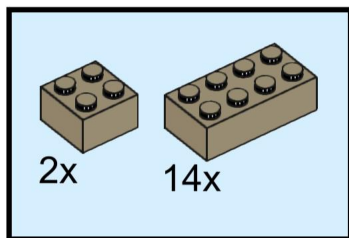

BRICKNOLOGY

54

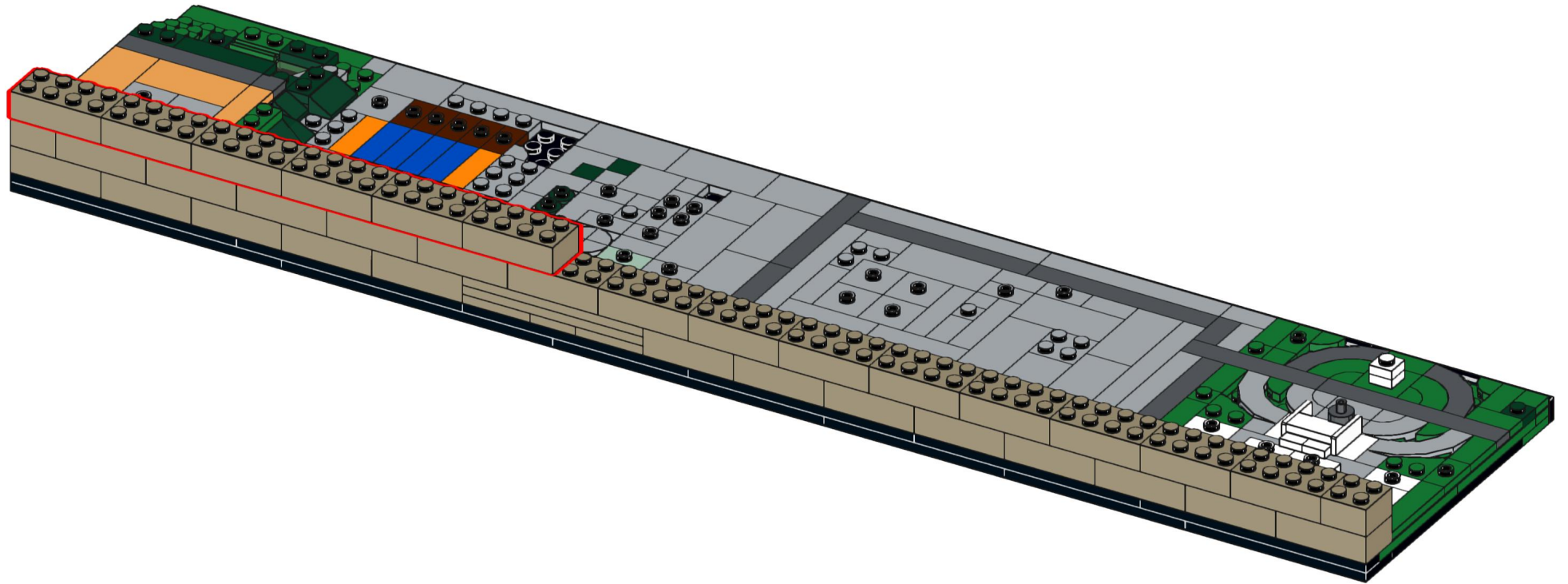
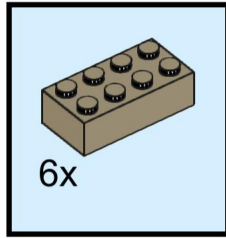

55

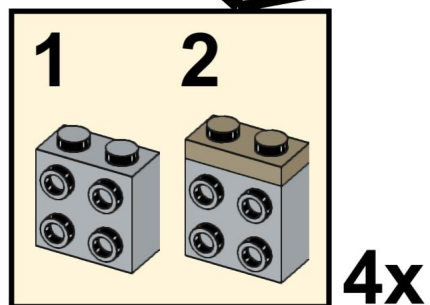
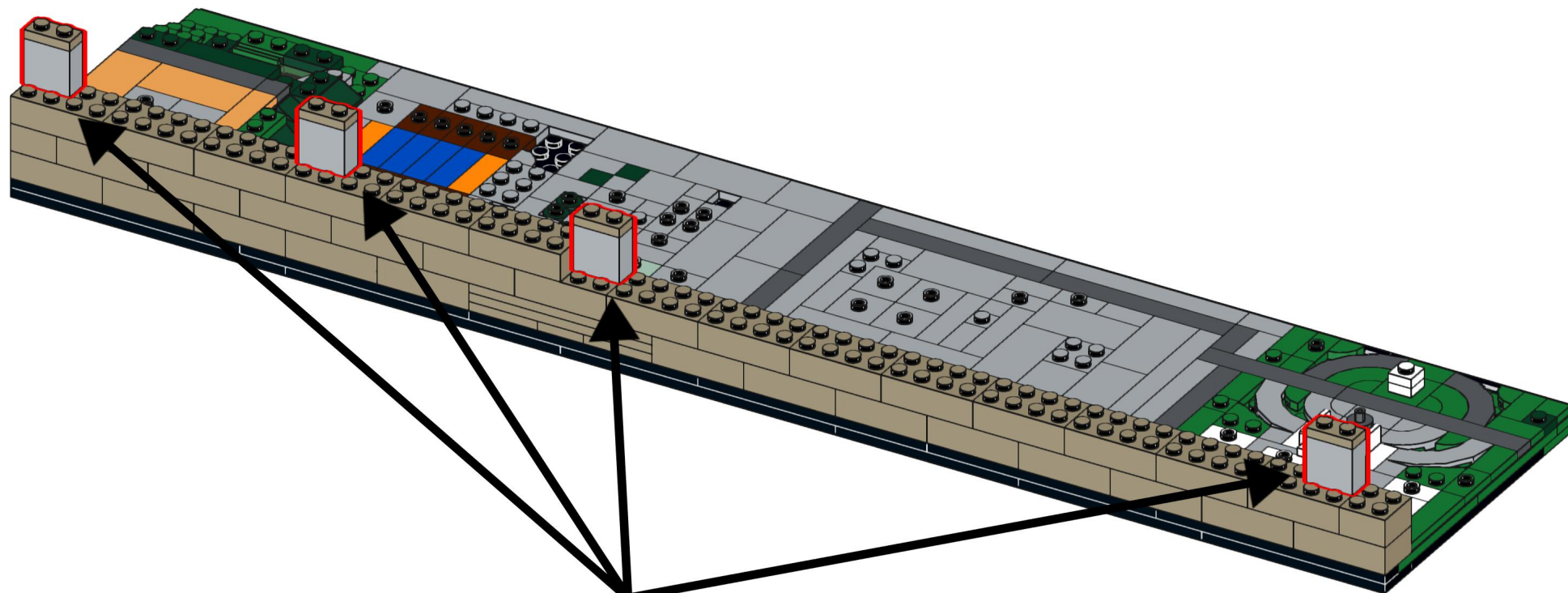
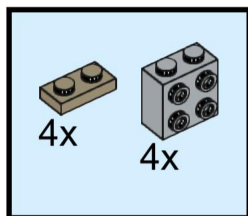

56

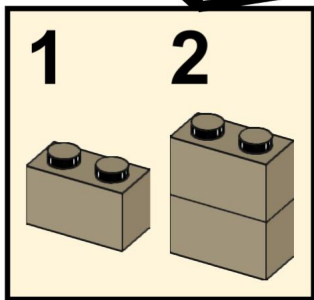
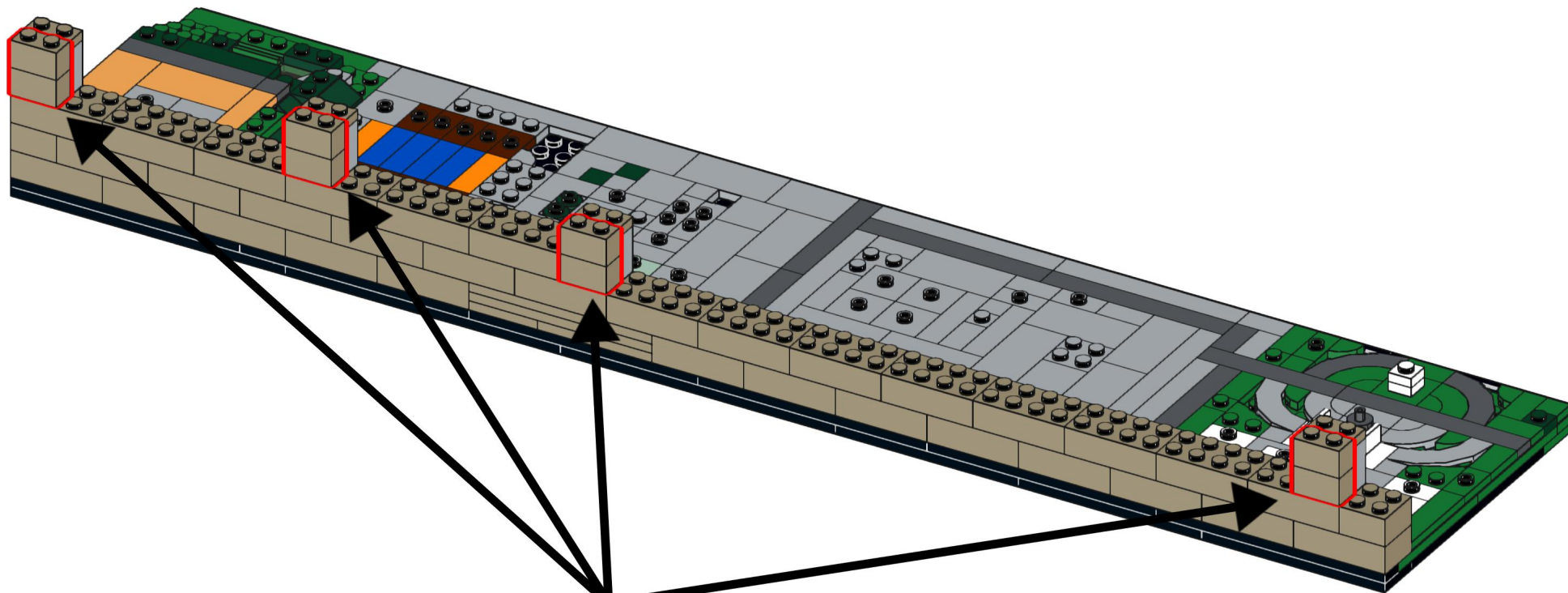
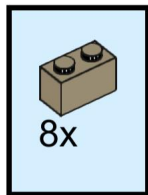

4x

57

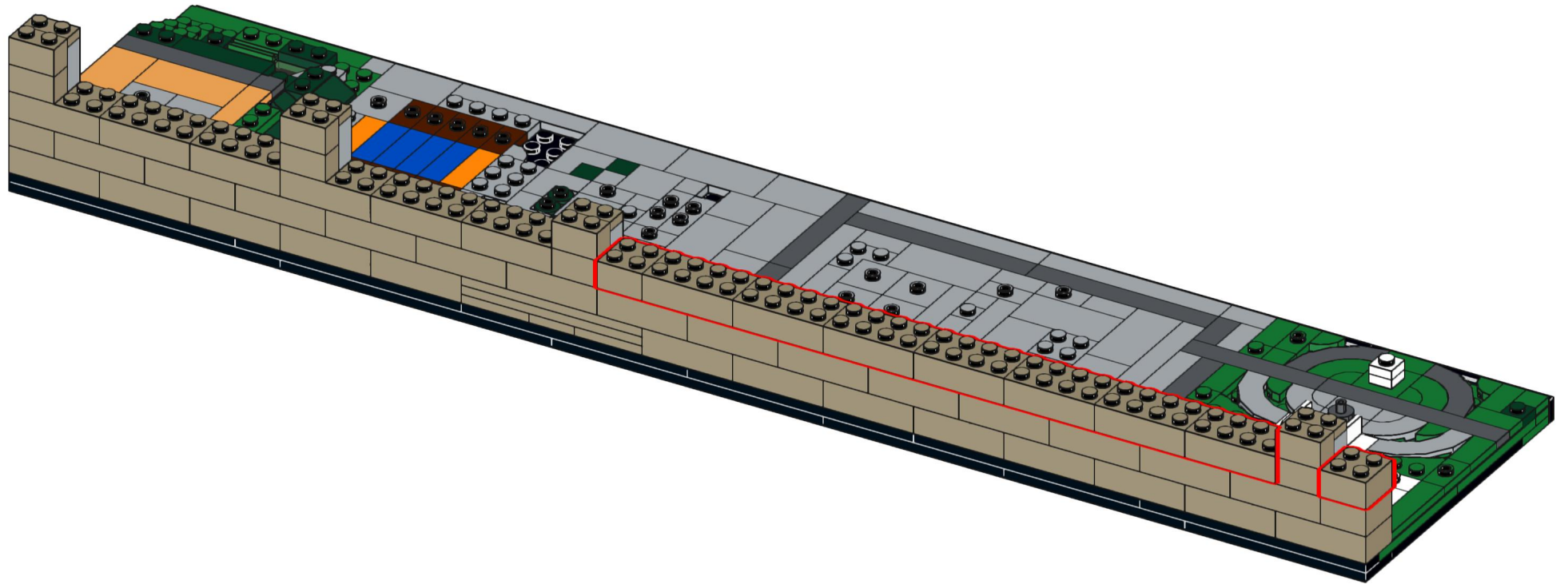
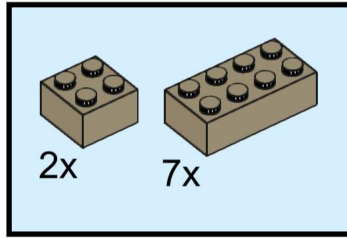

58

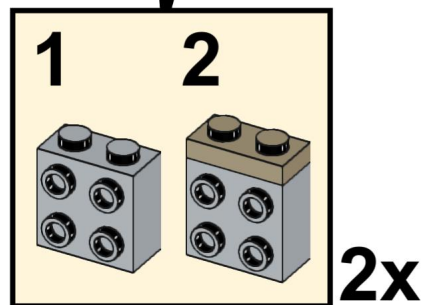
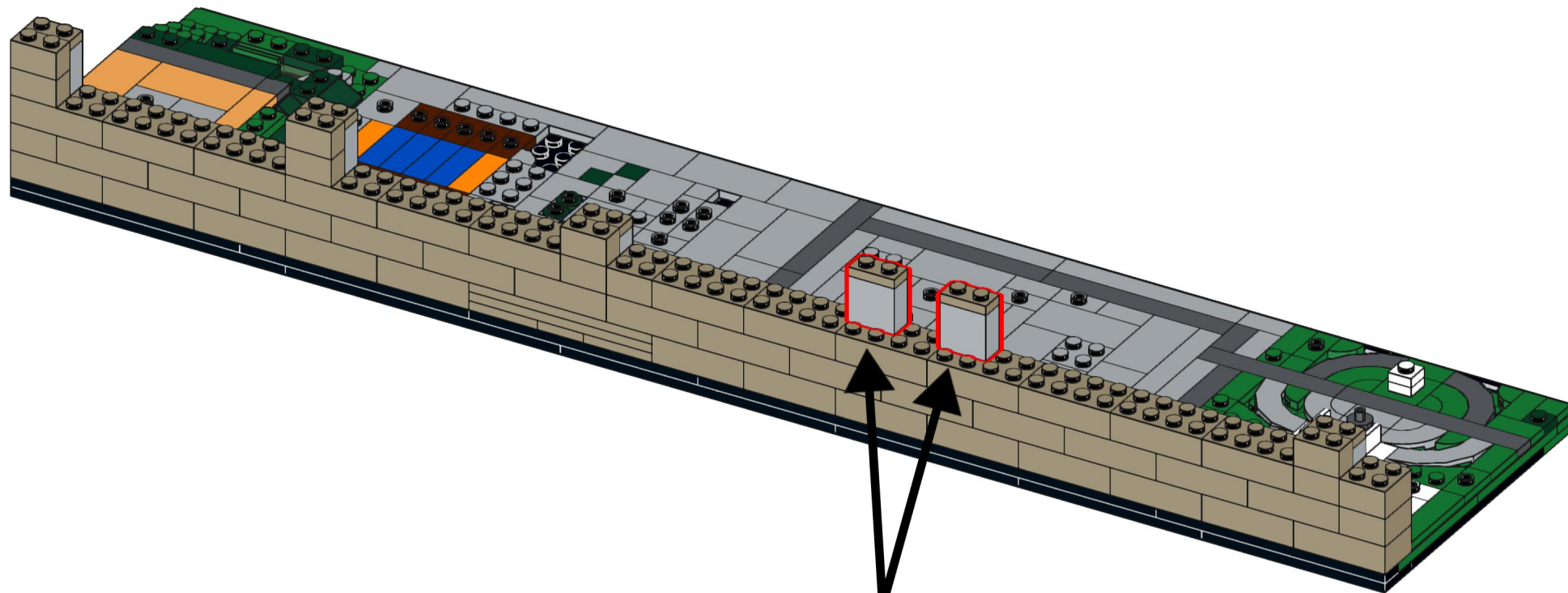
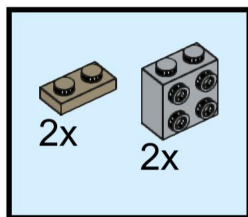

59

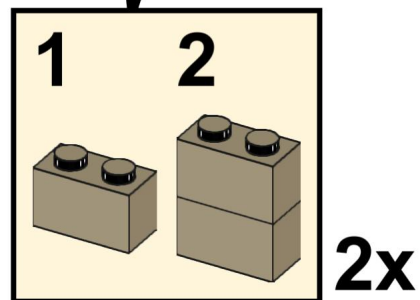
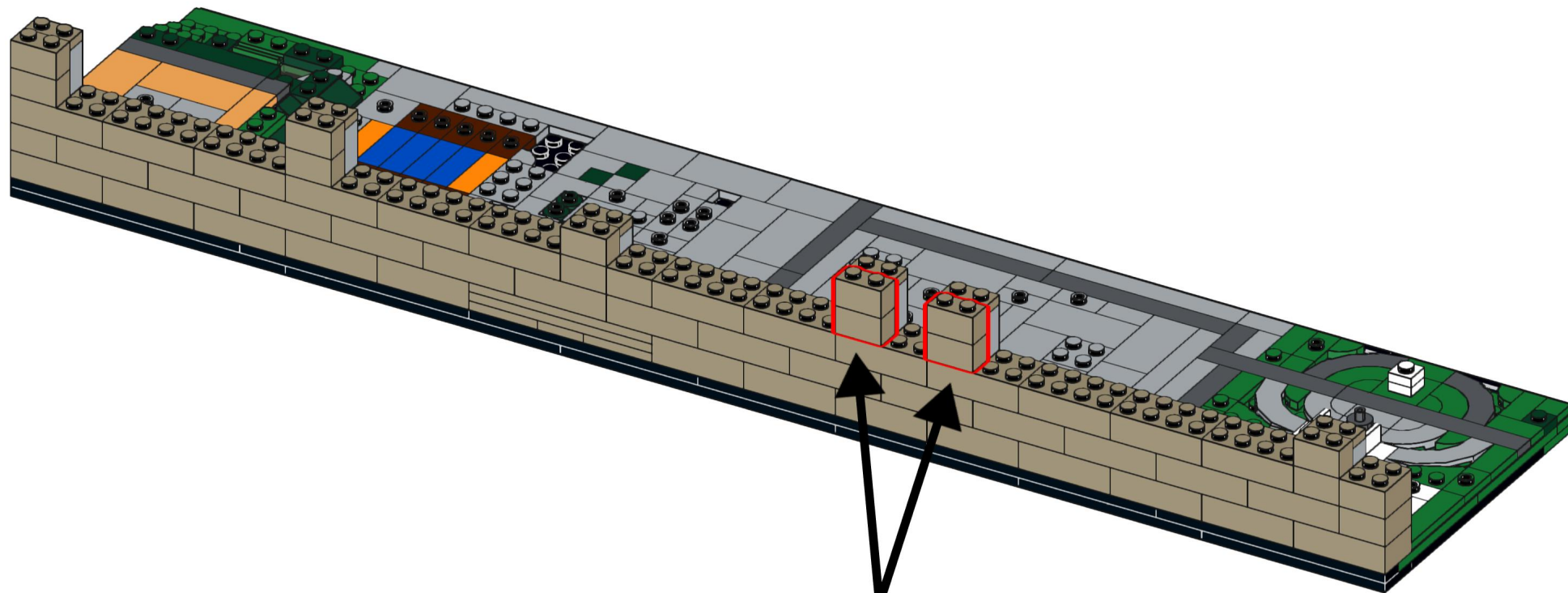
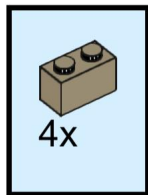

60

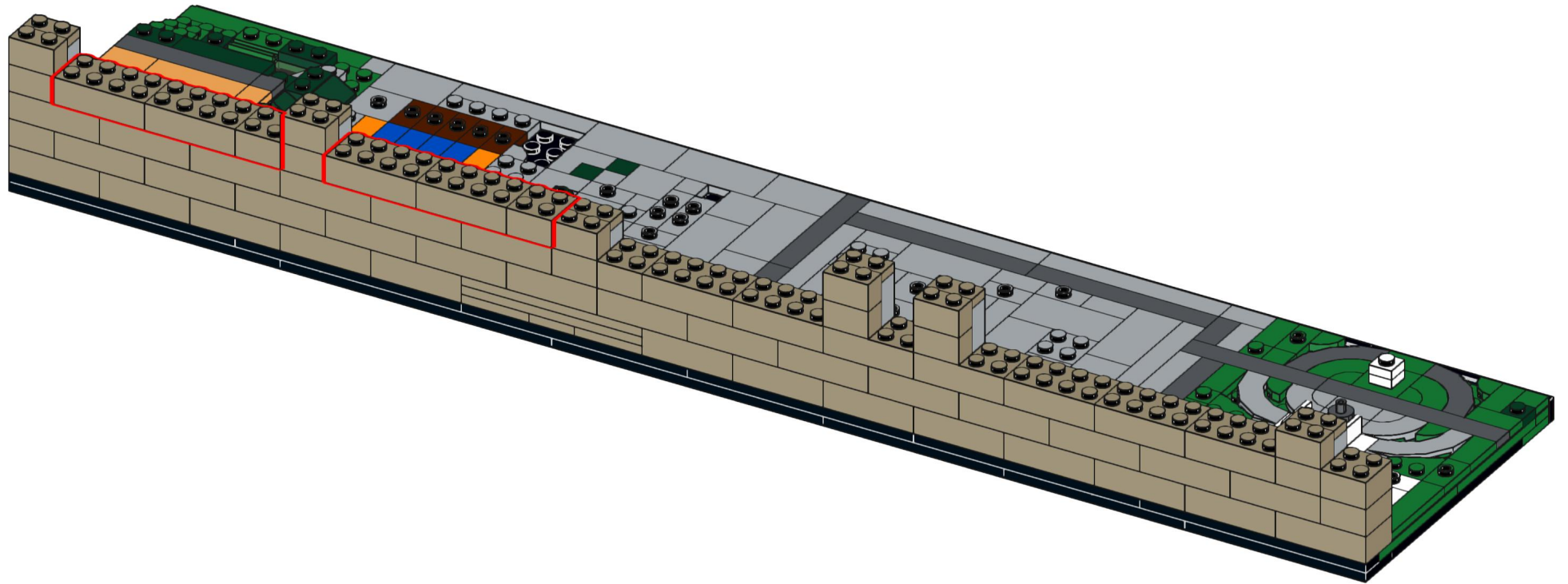
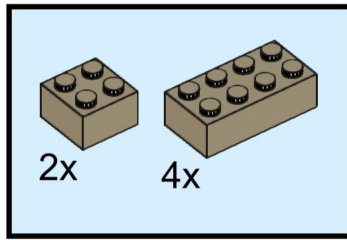

61

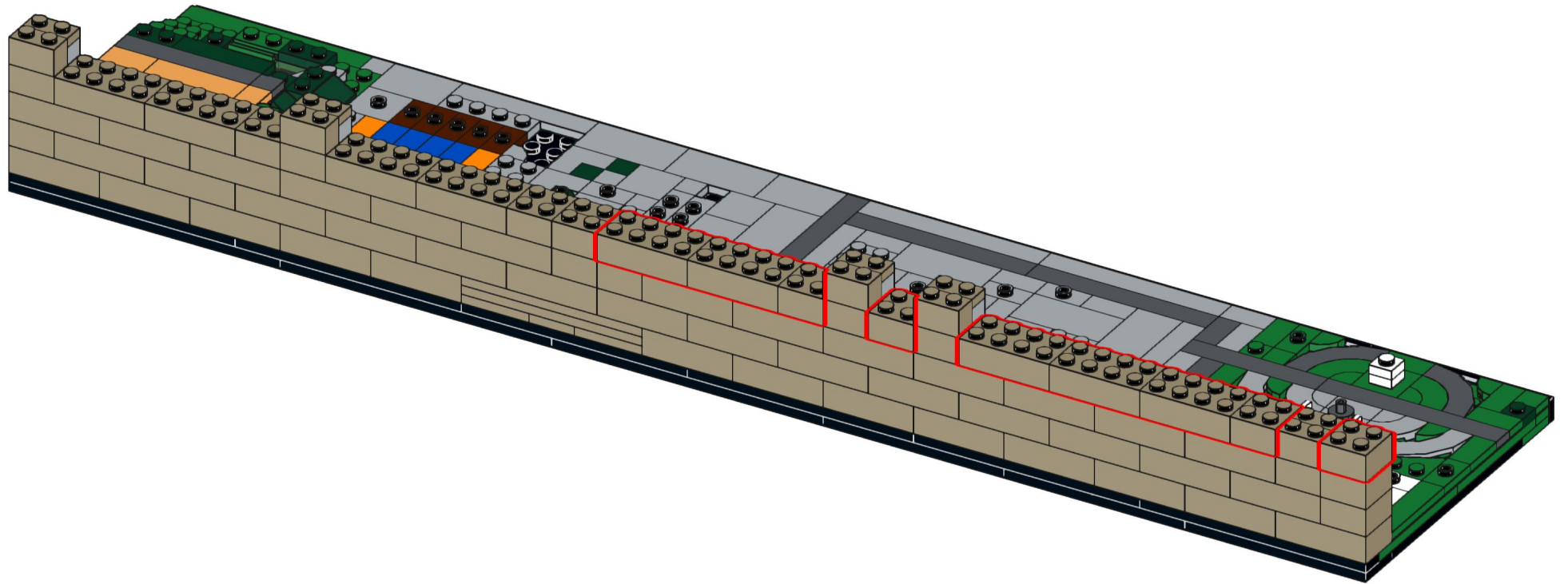
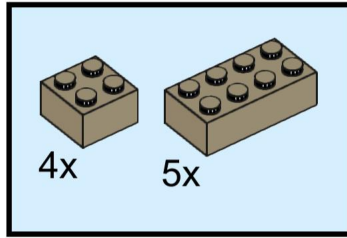

62

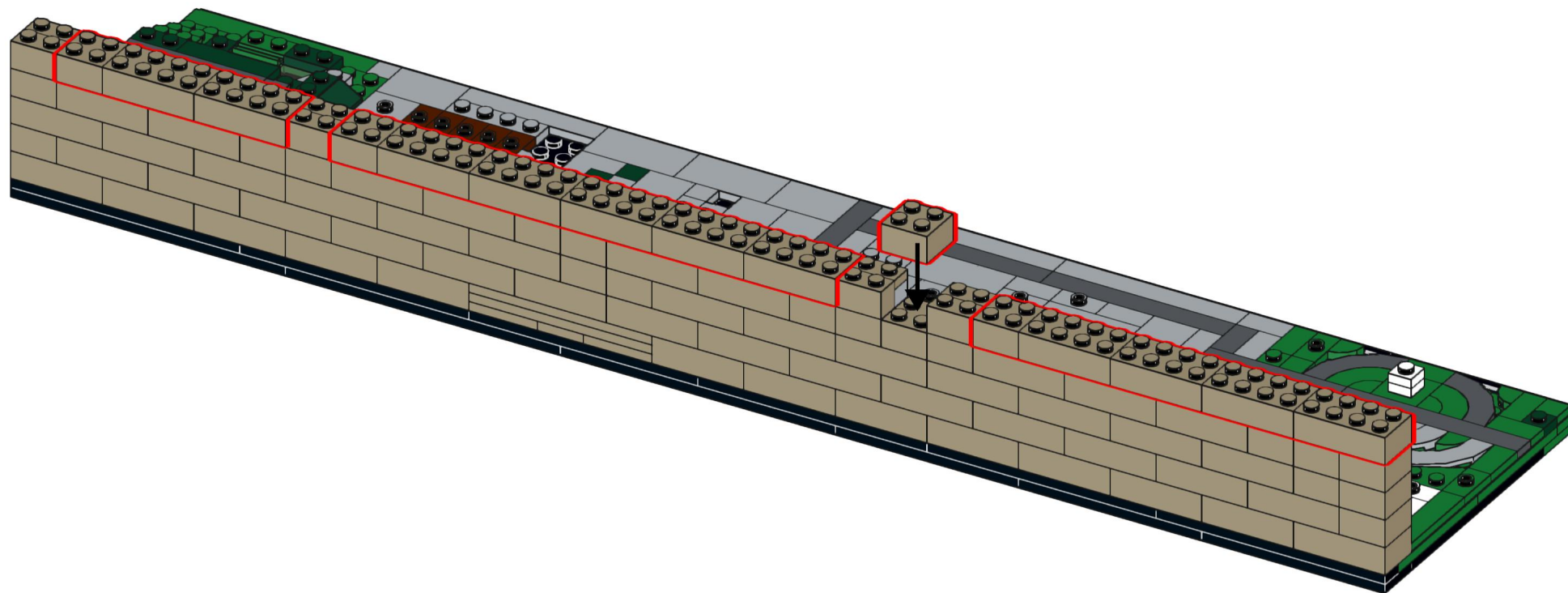
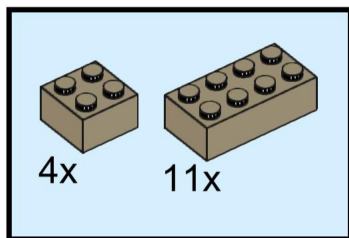

63

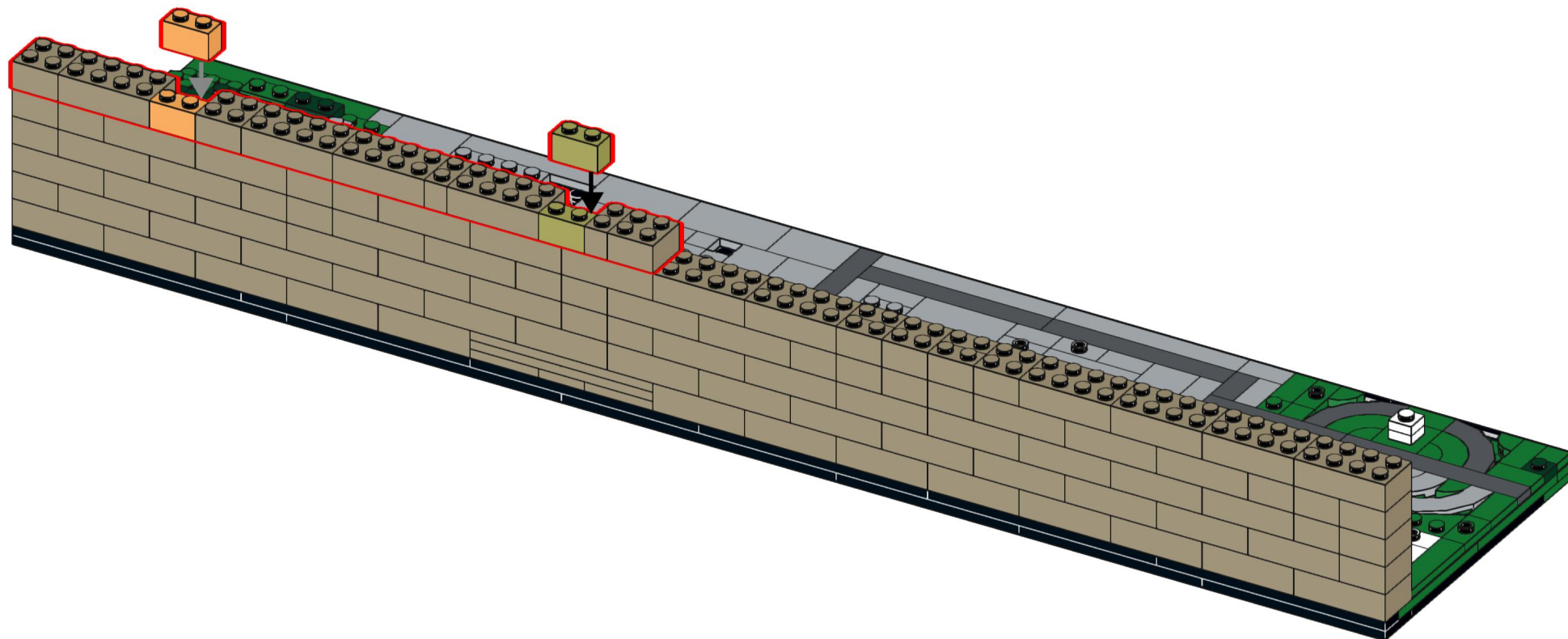
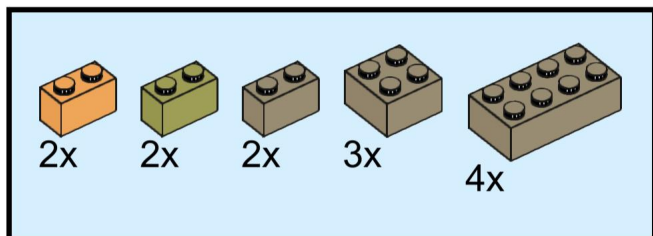

64

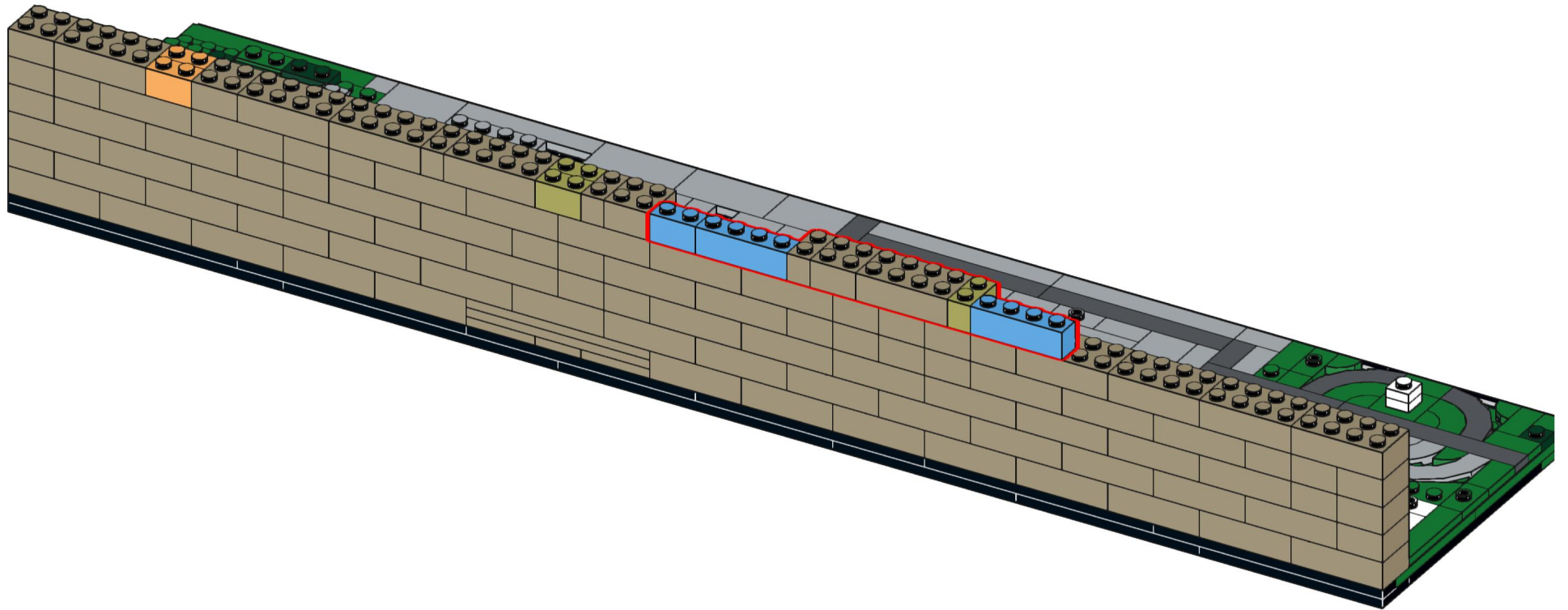
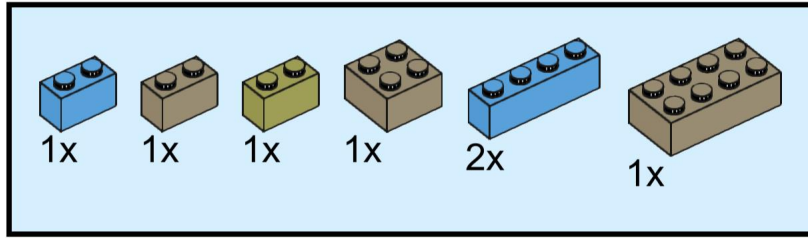

65

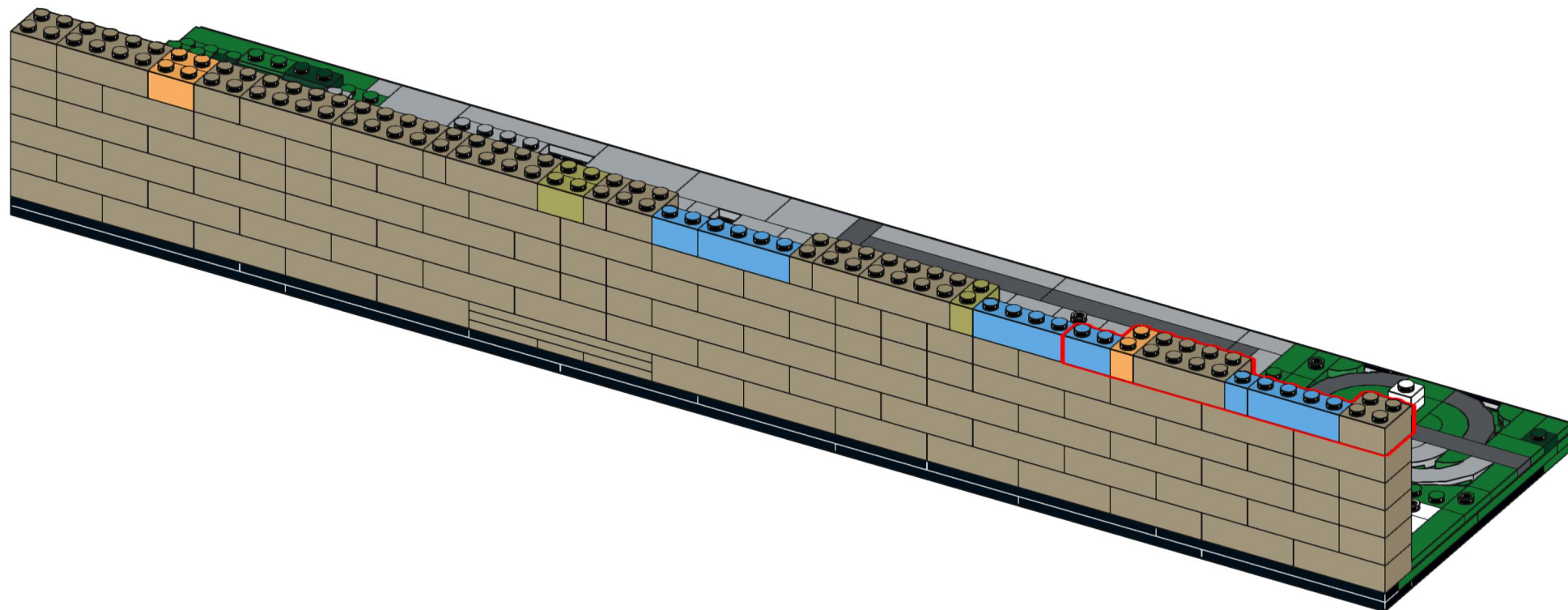
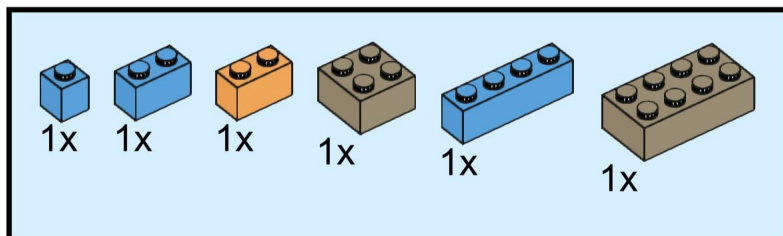

66

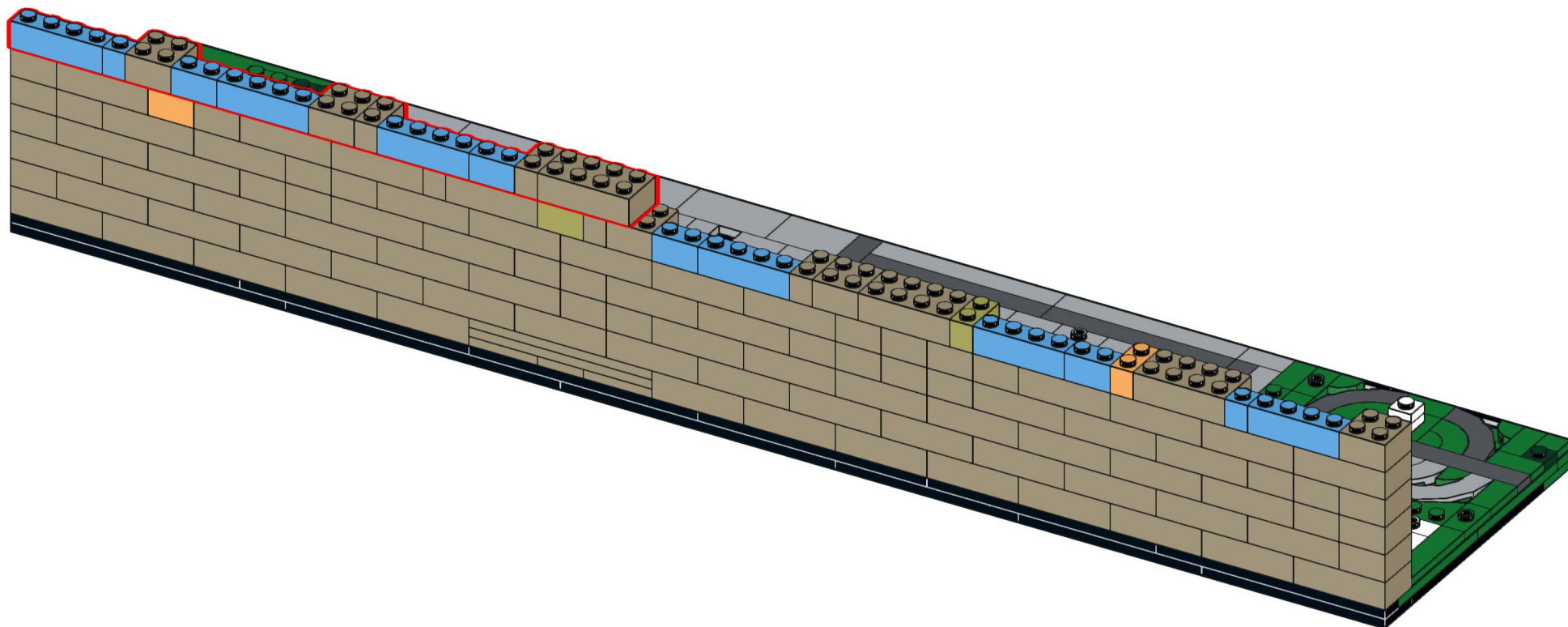
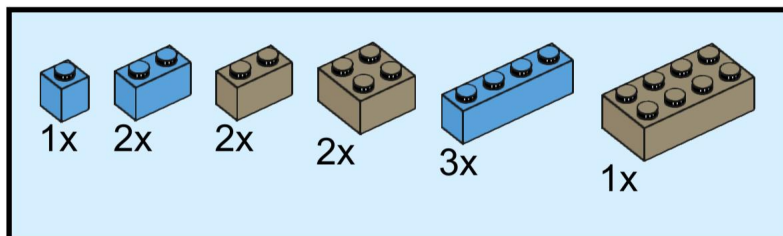

67

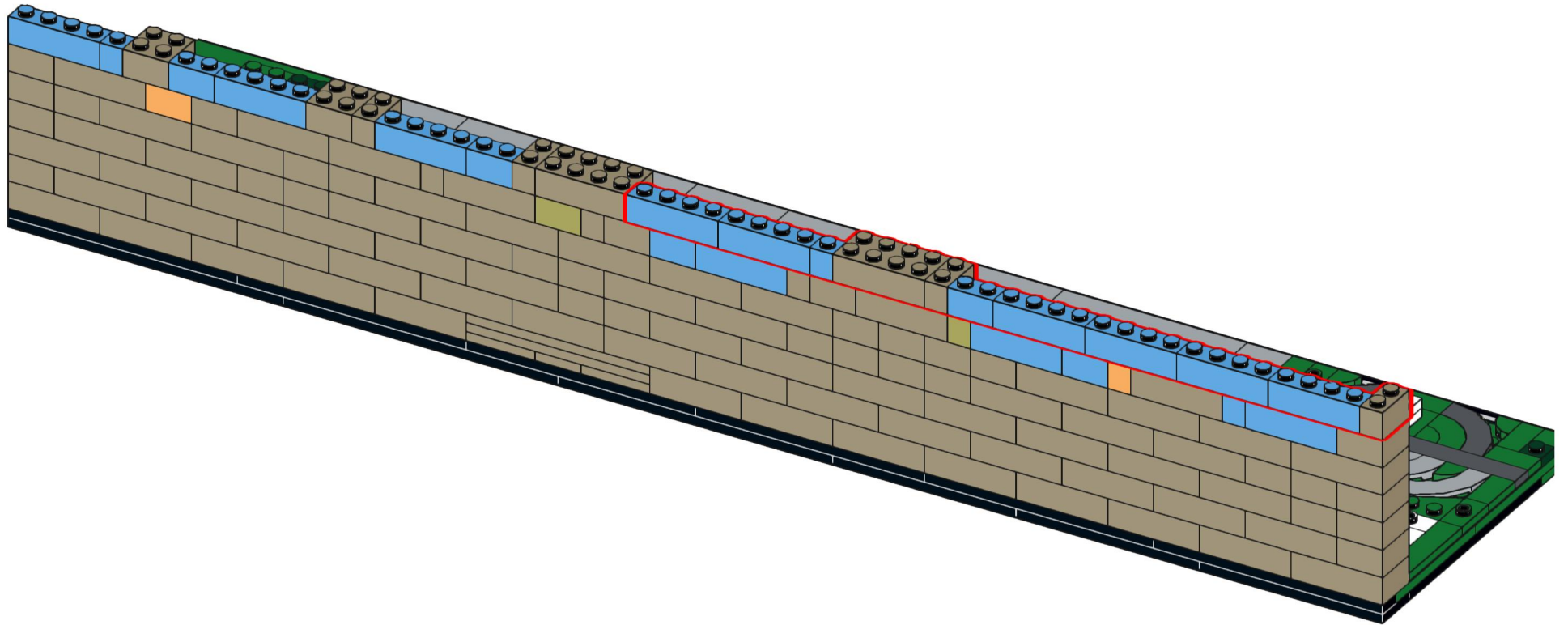
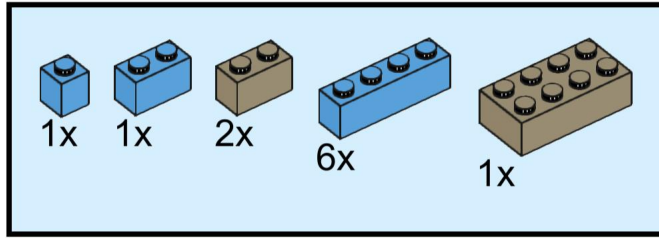

68

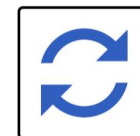
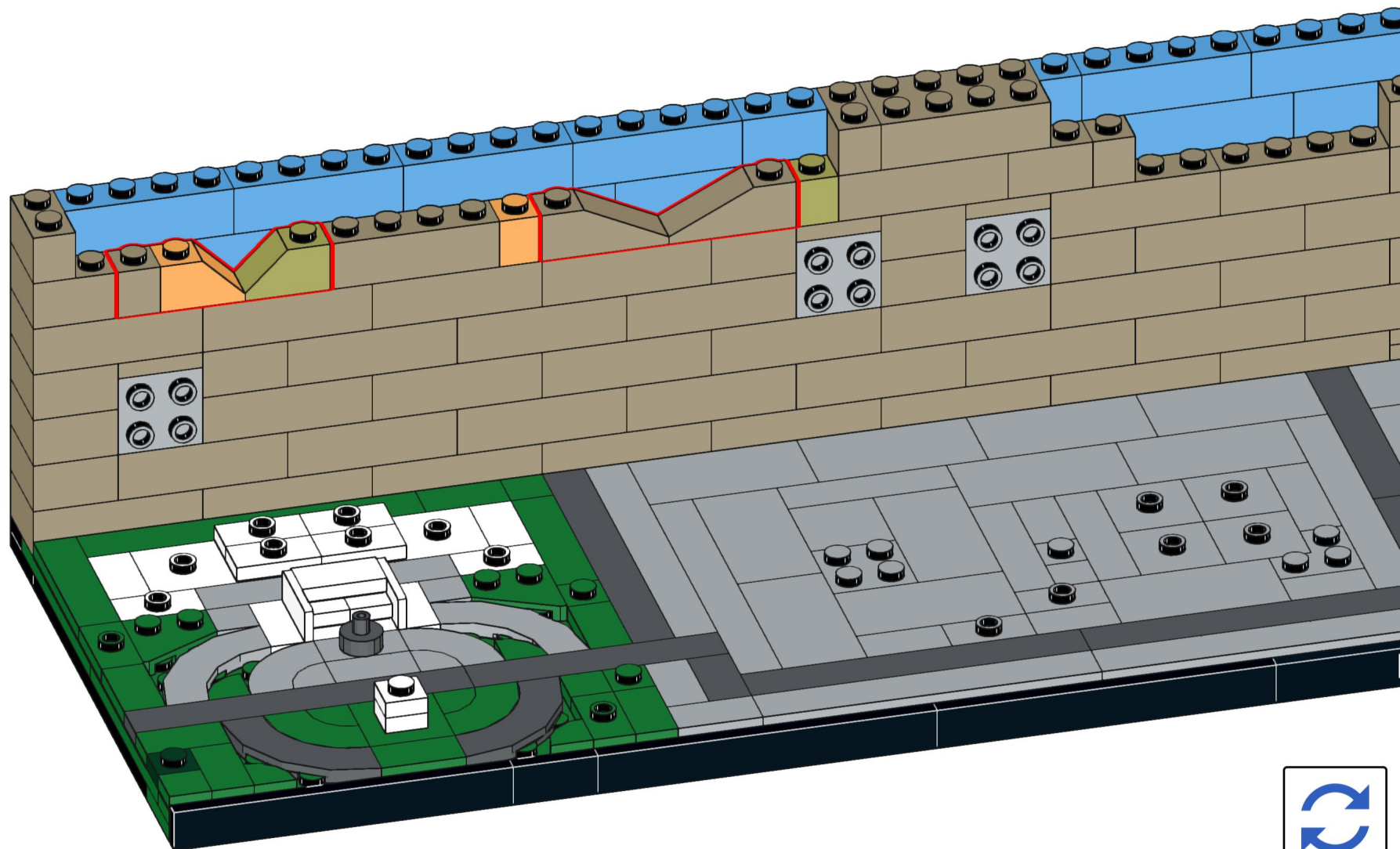
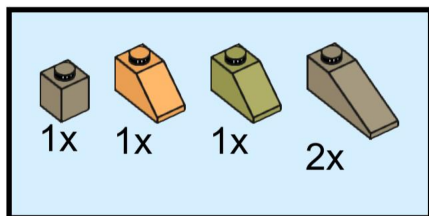

BRICKNOWLOGY

69

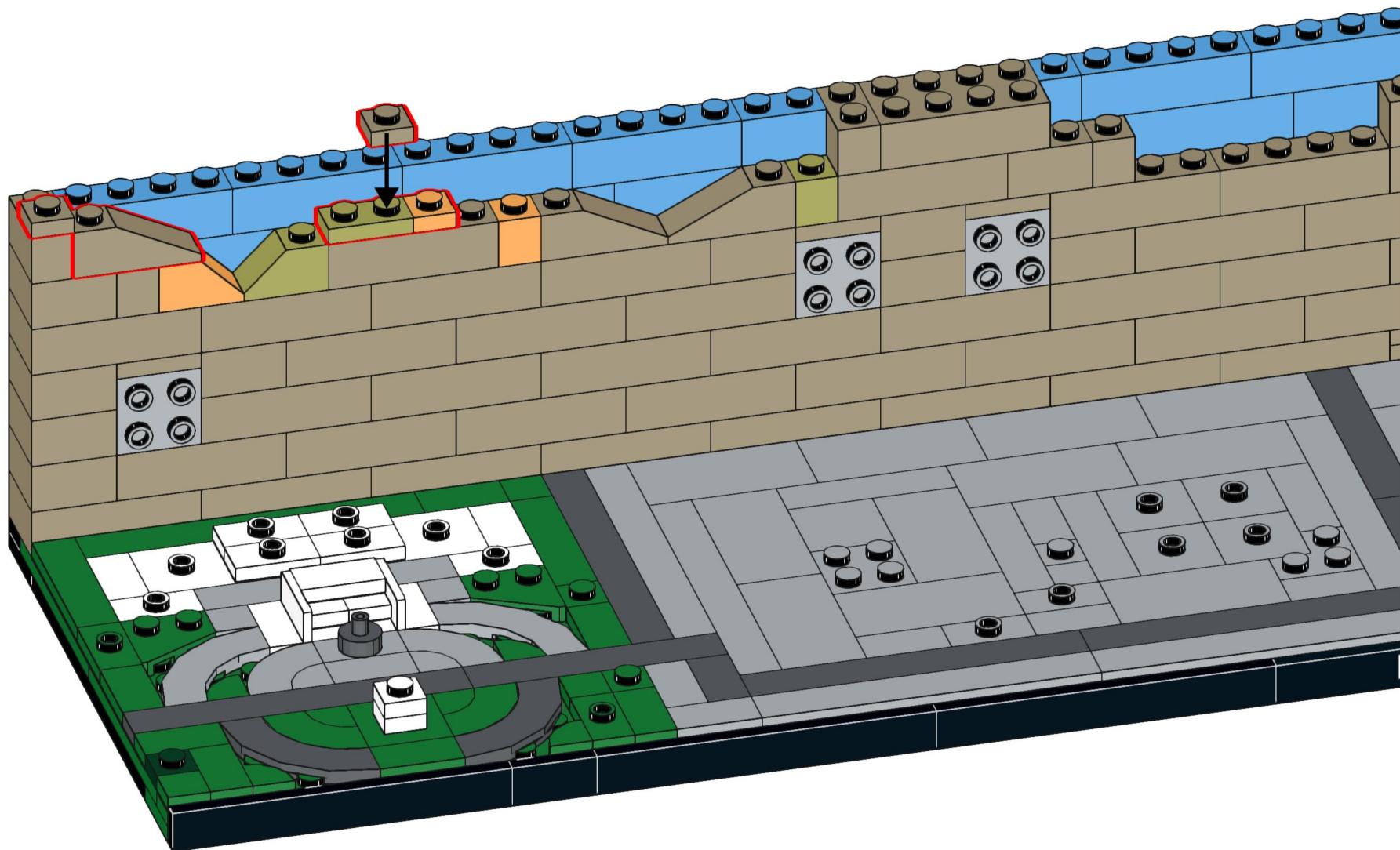
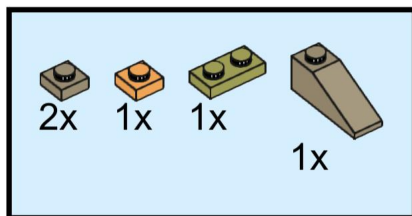

70

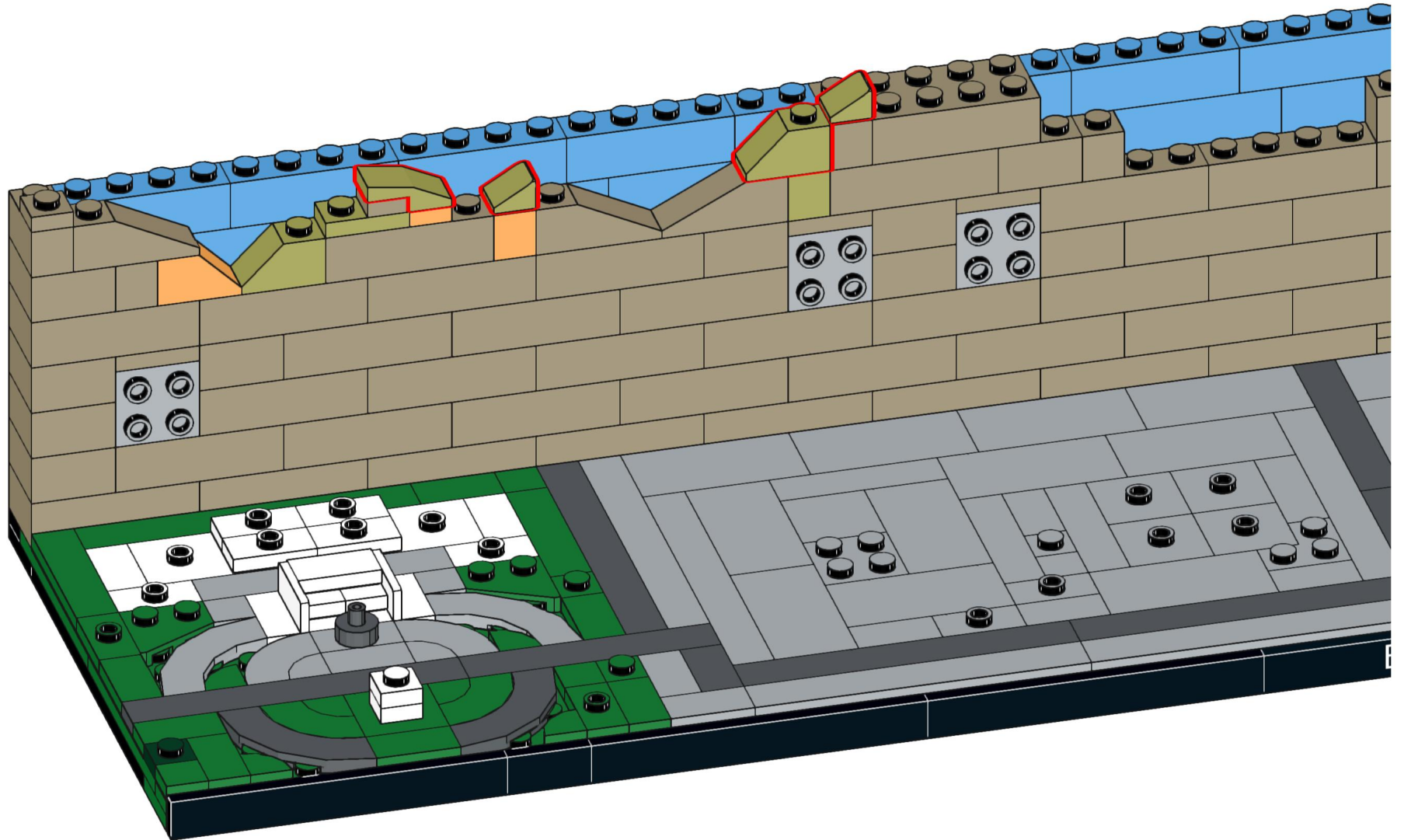
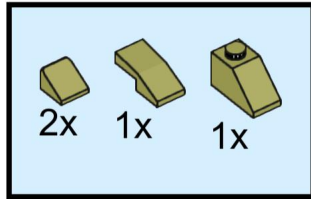

71

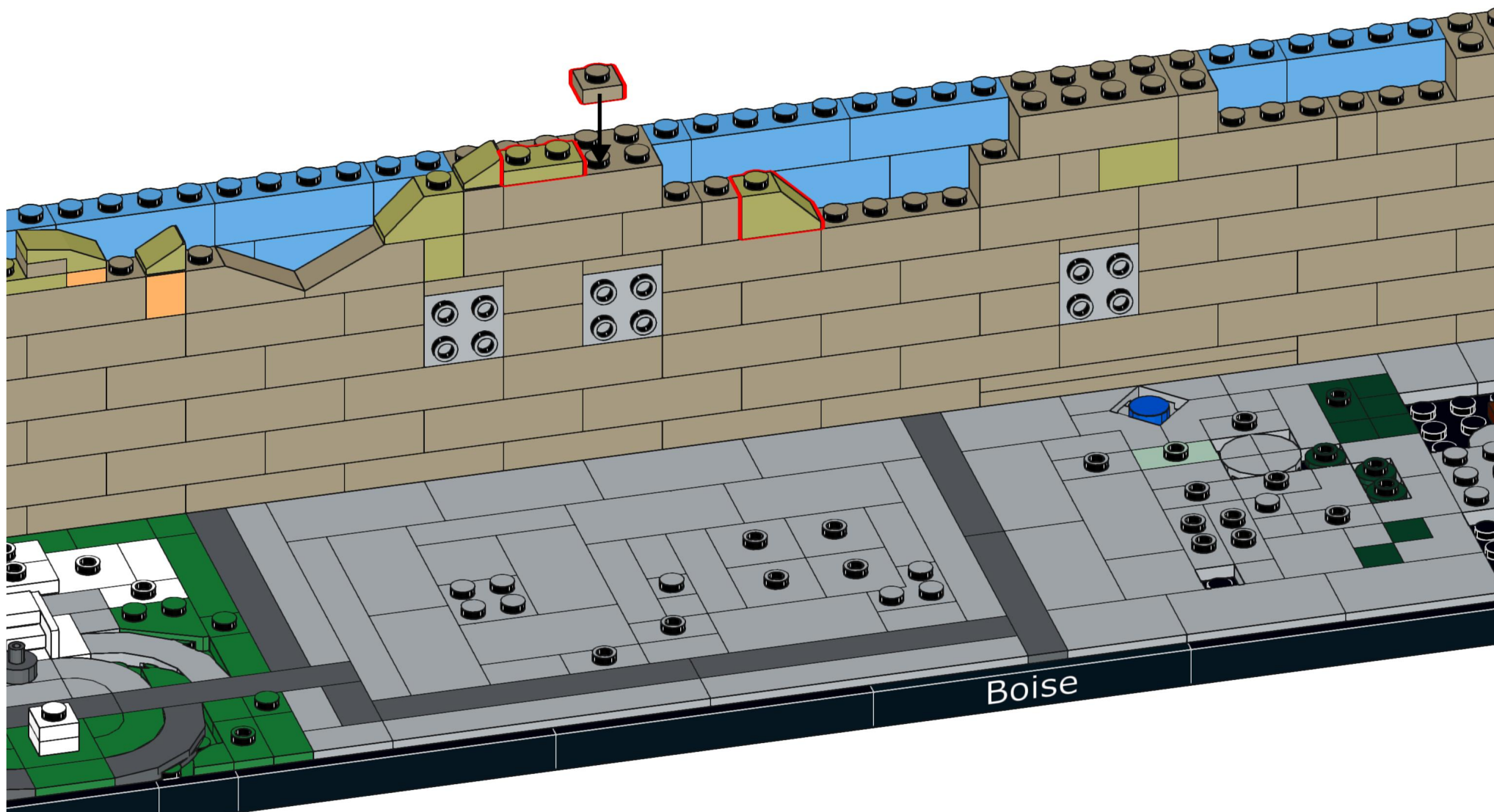
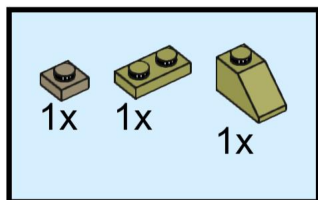

72

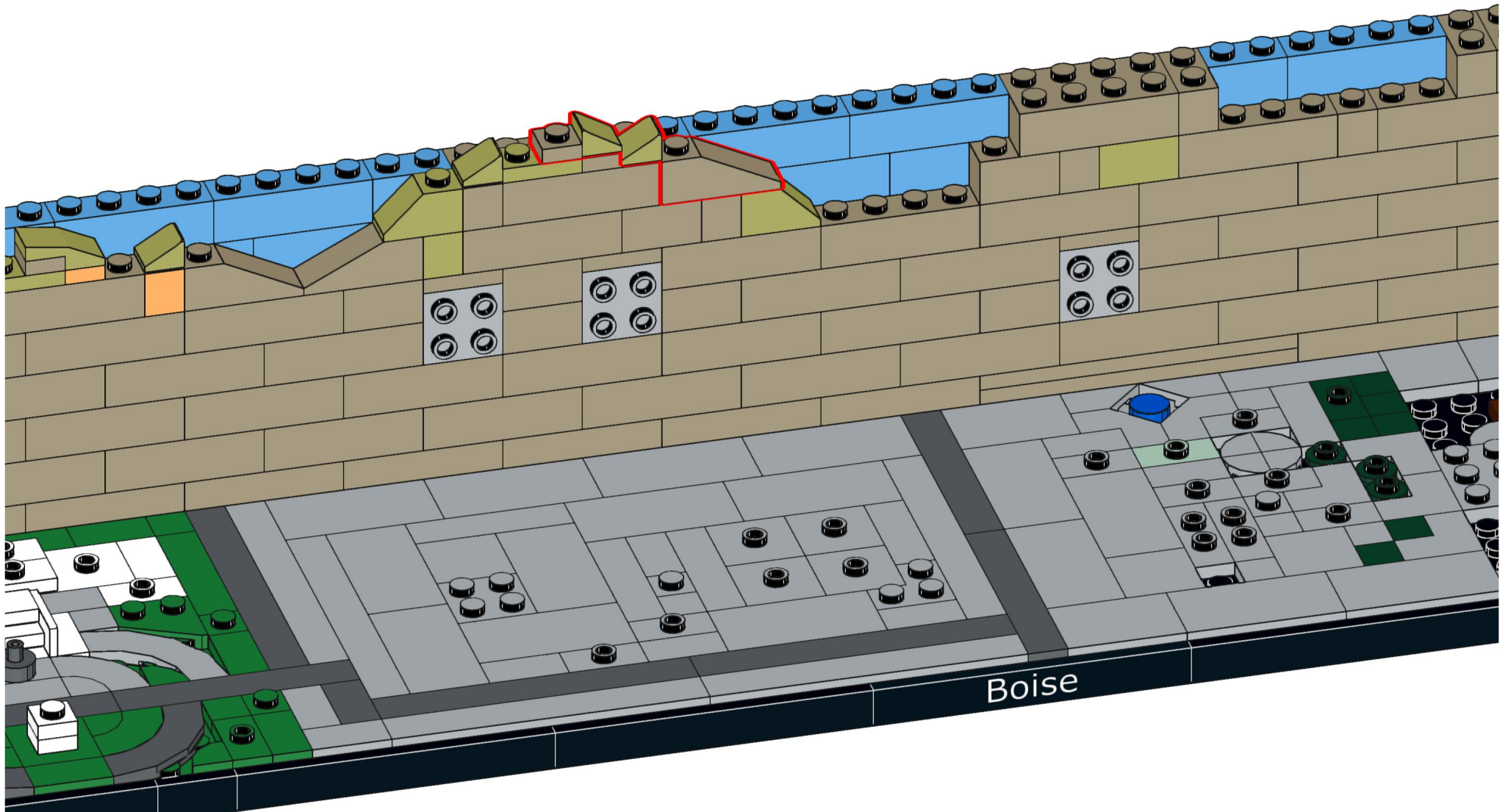
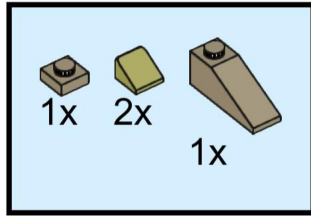

73

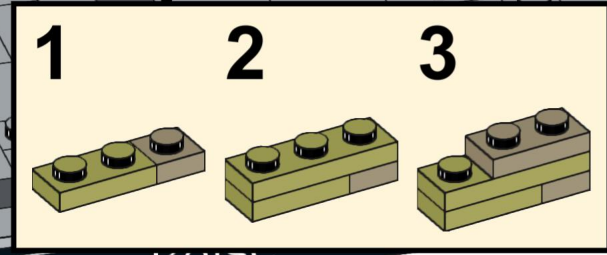
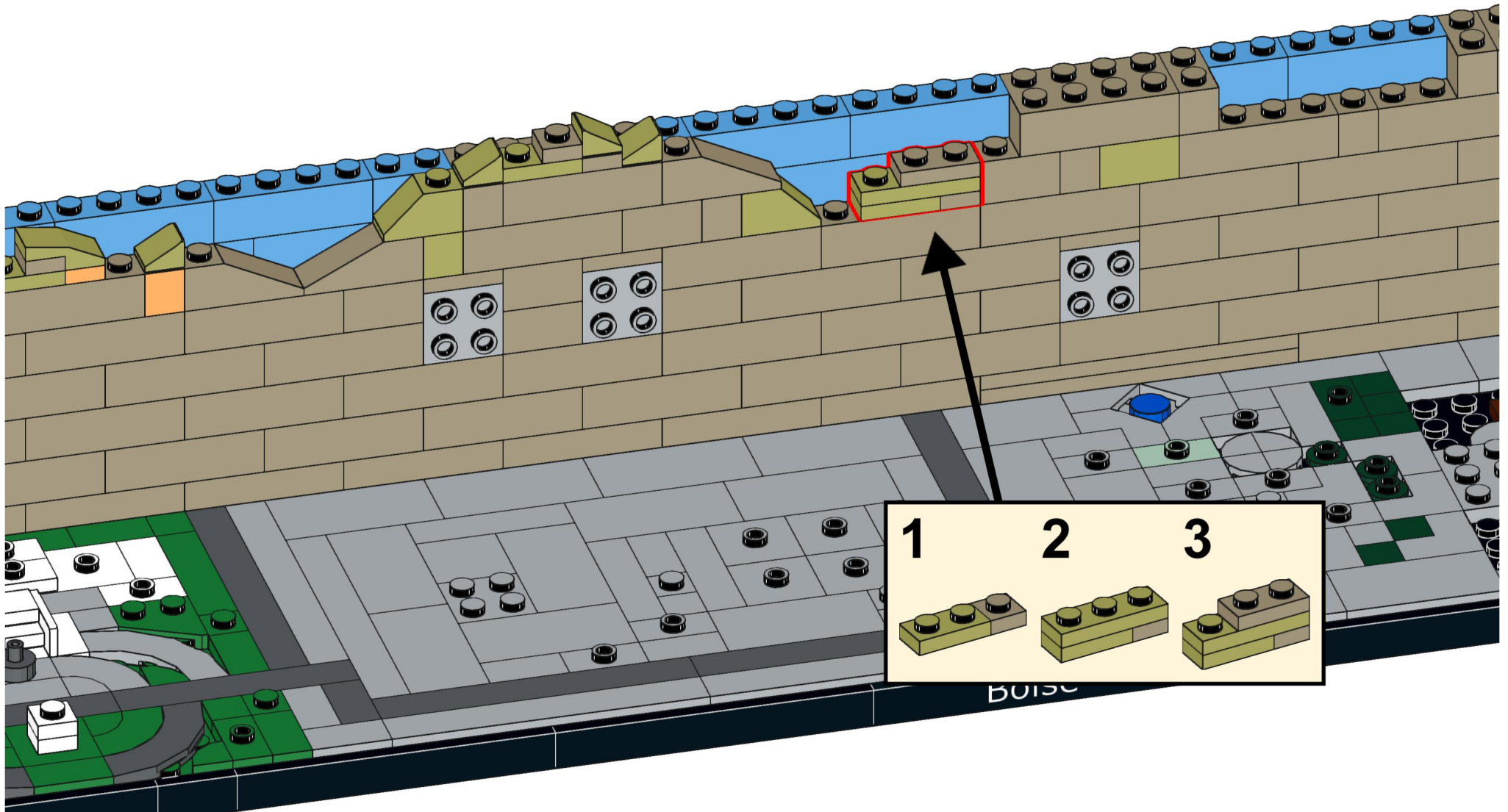
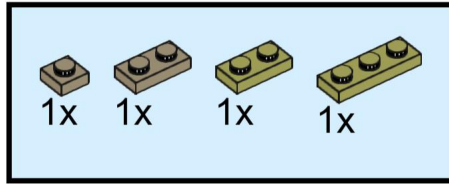

74

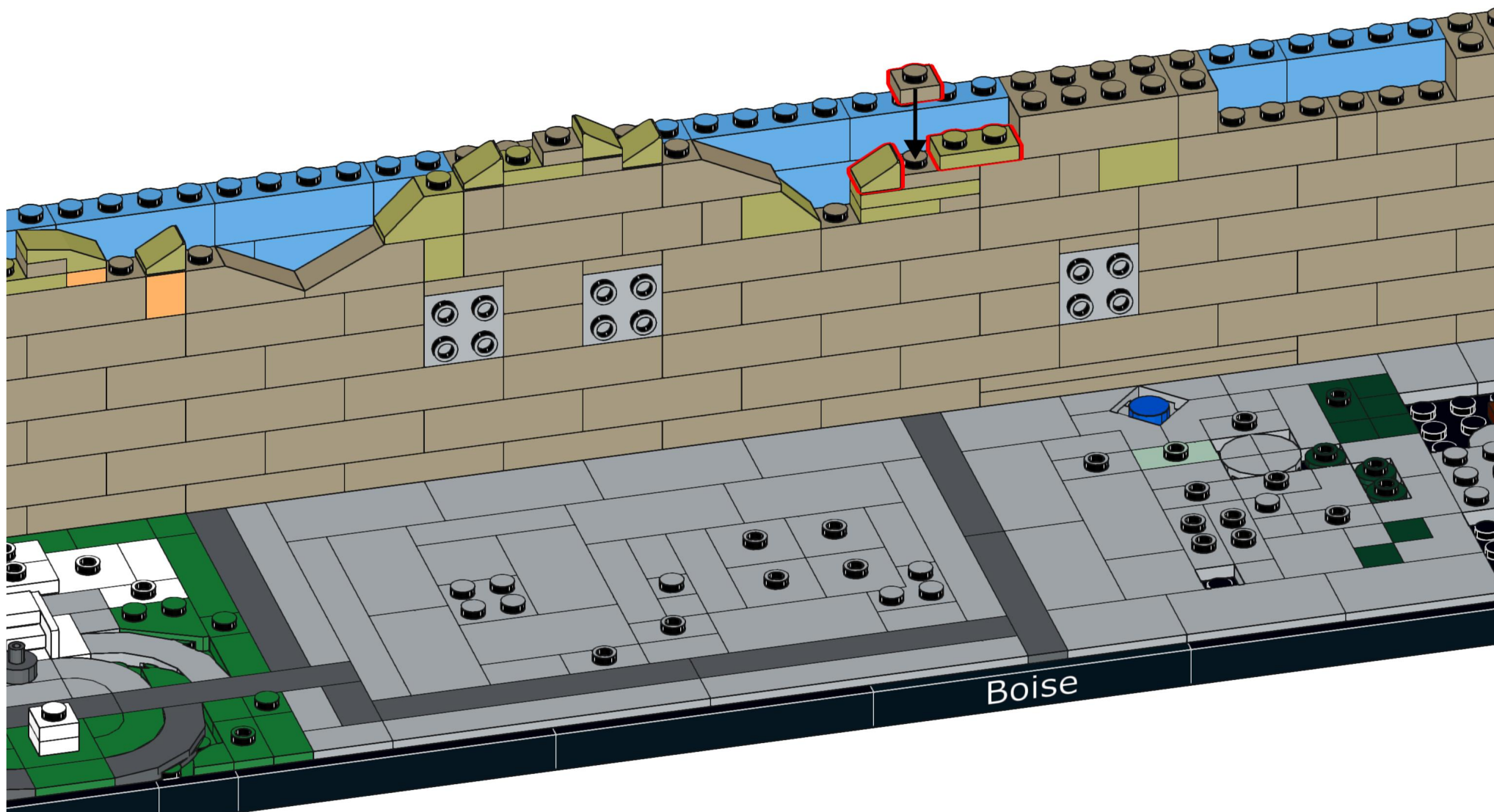
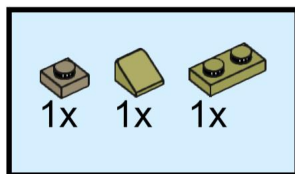

75

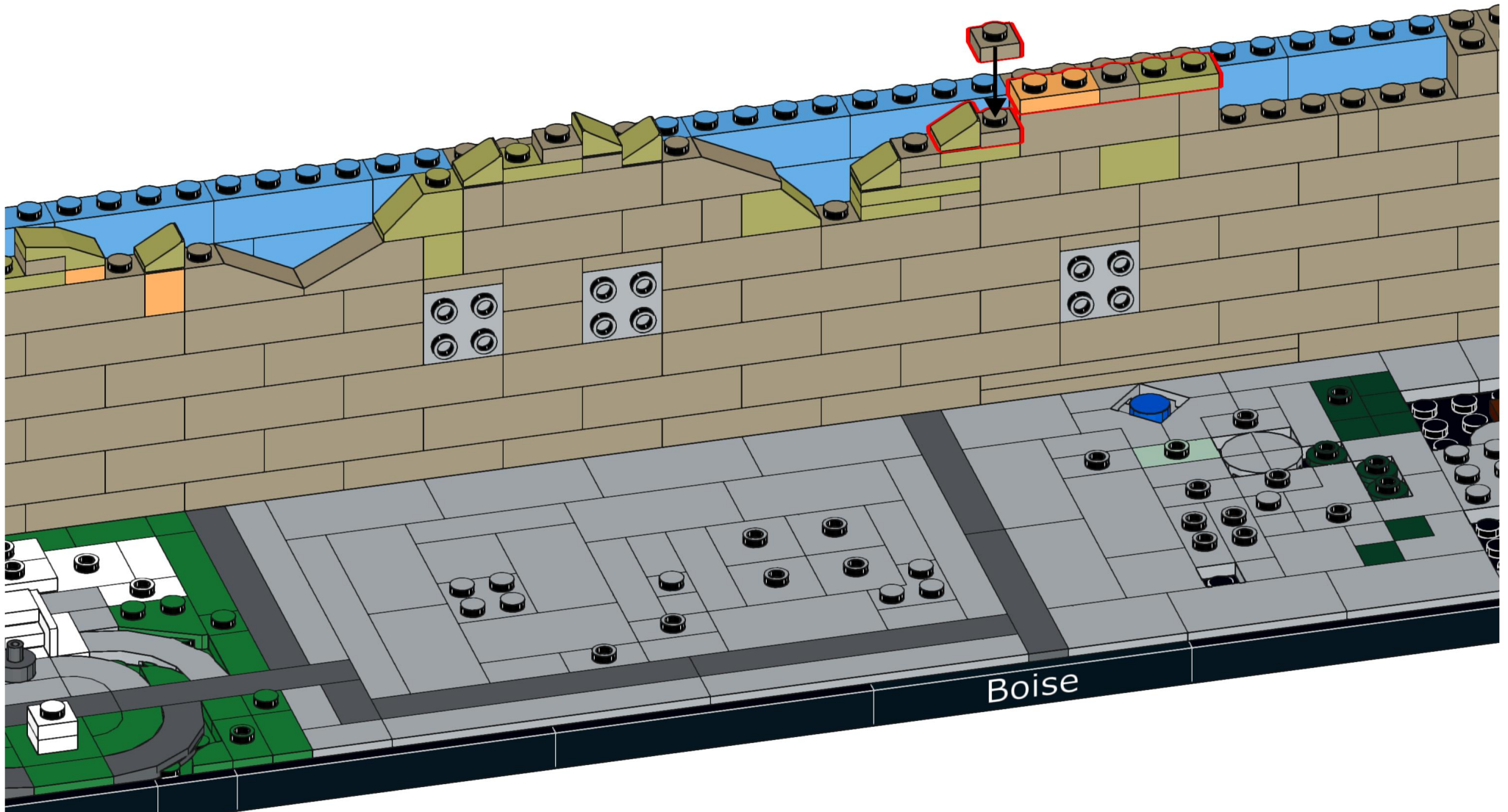
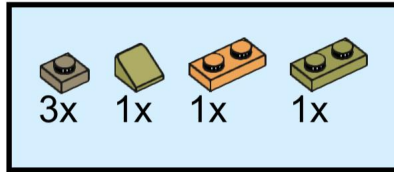

76

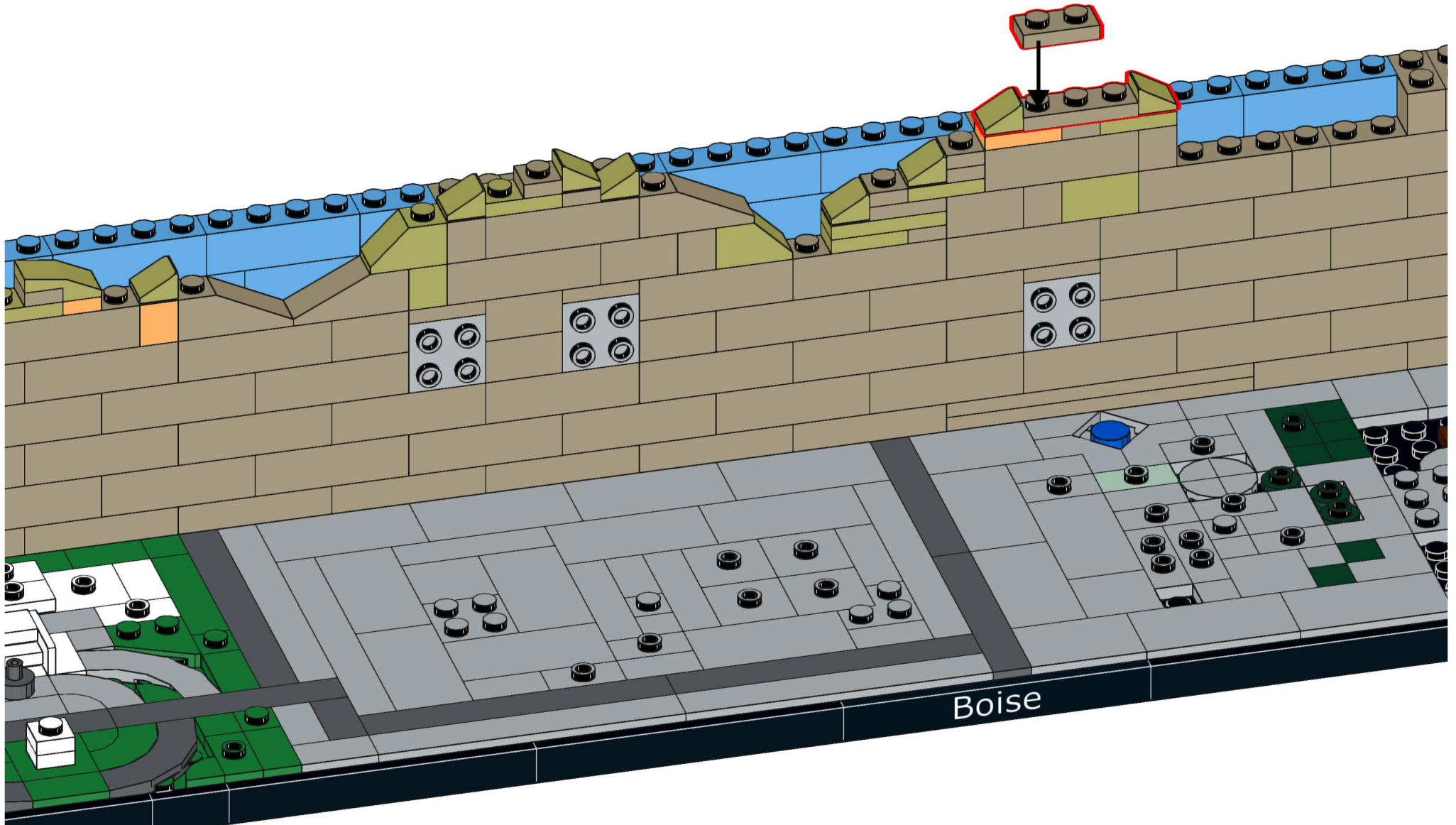
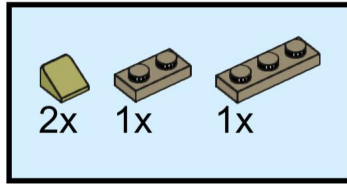

Boise

77

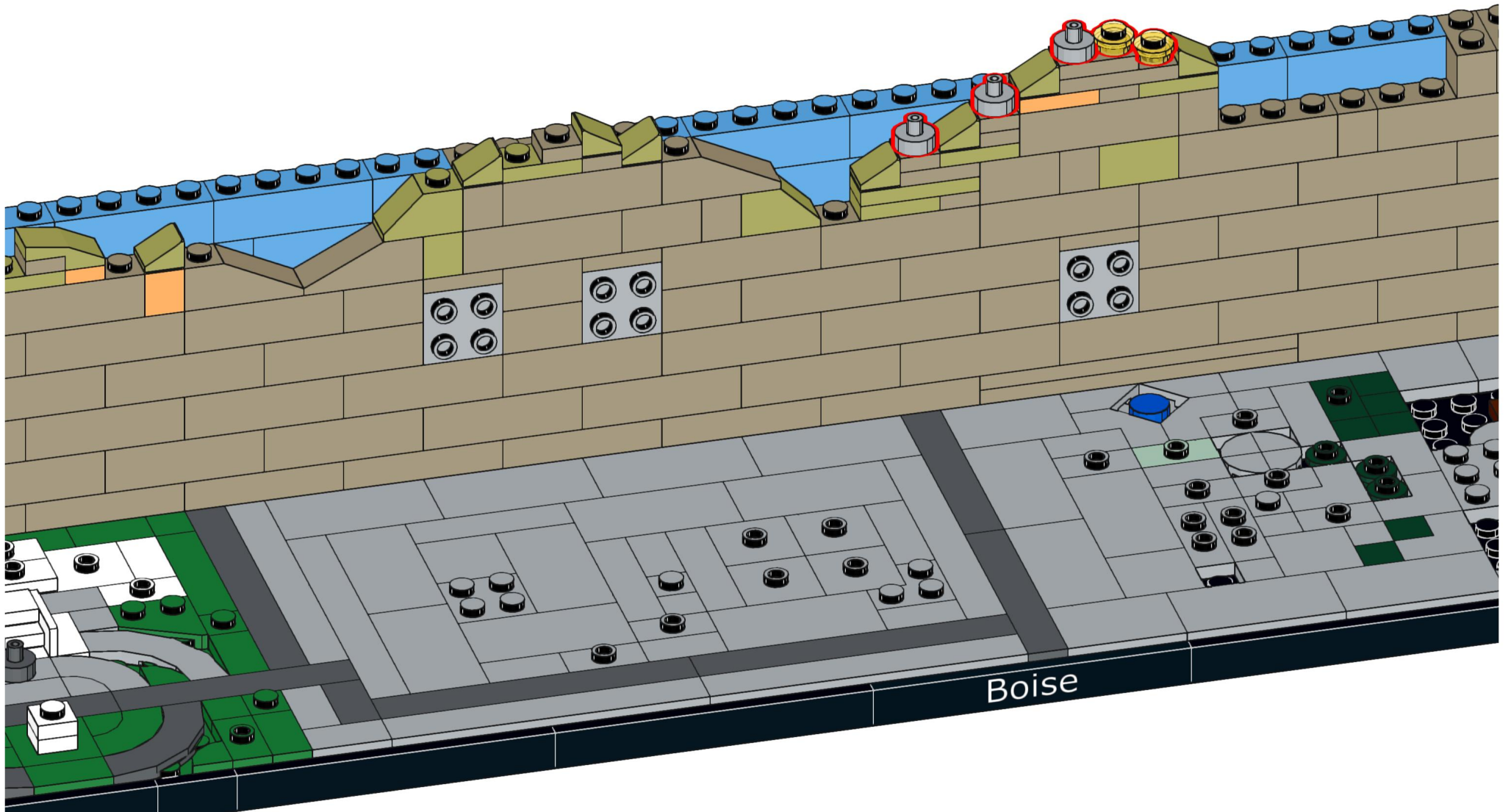

78

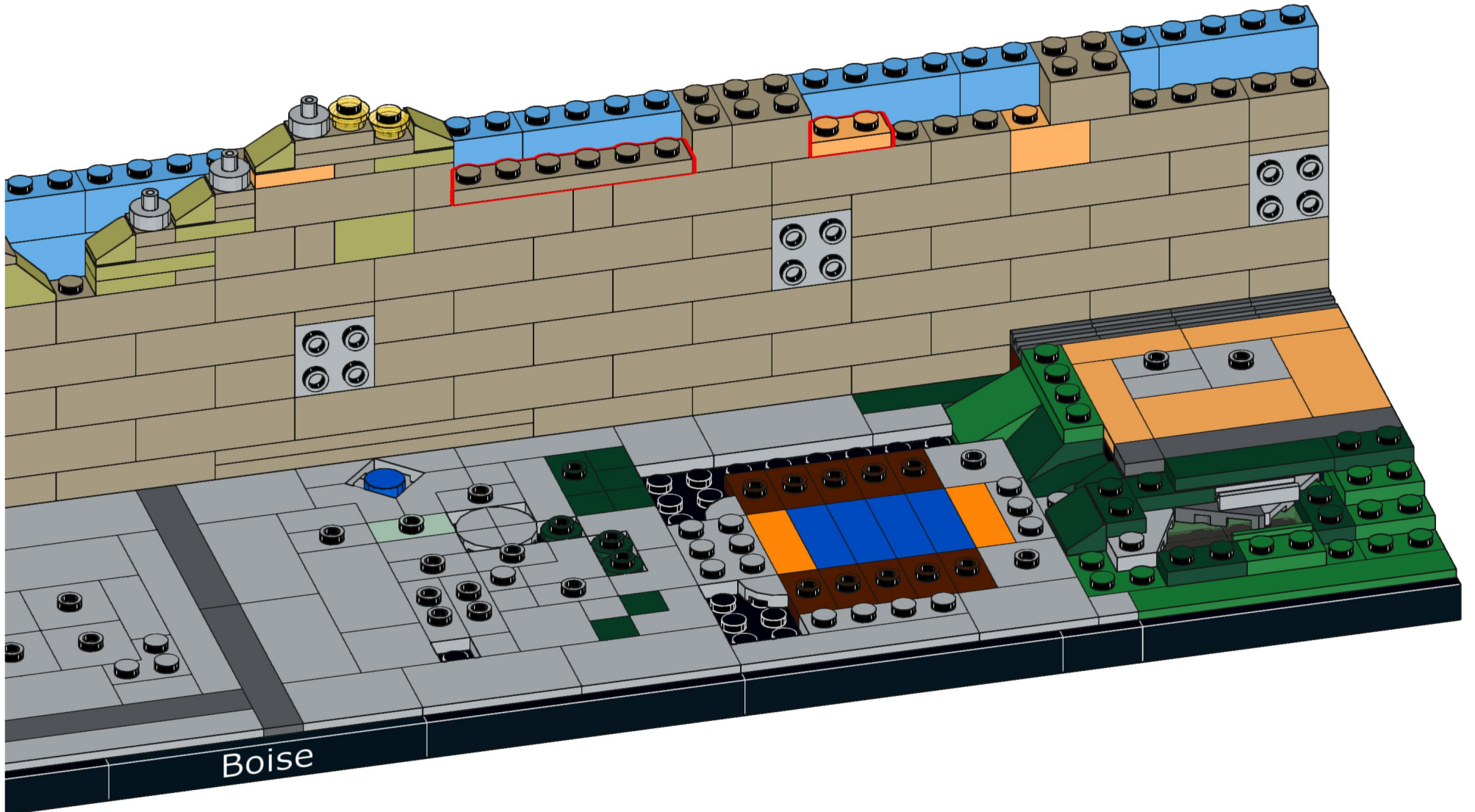
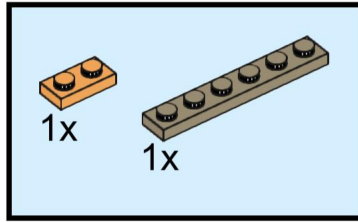

79

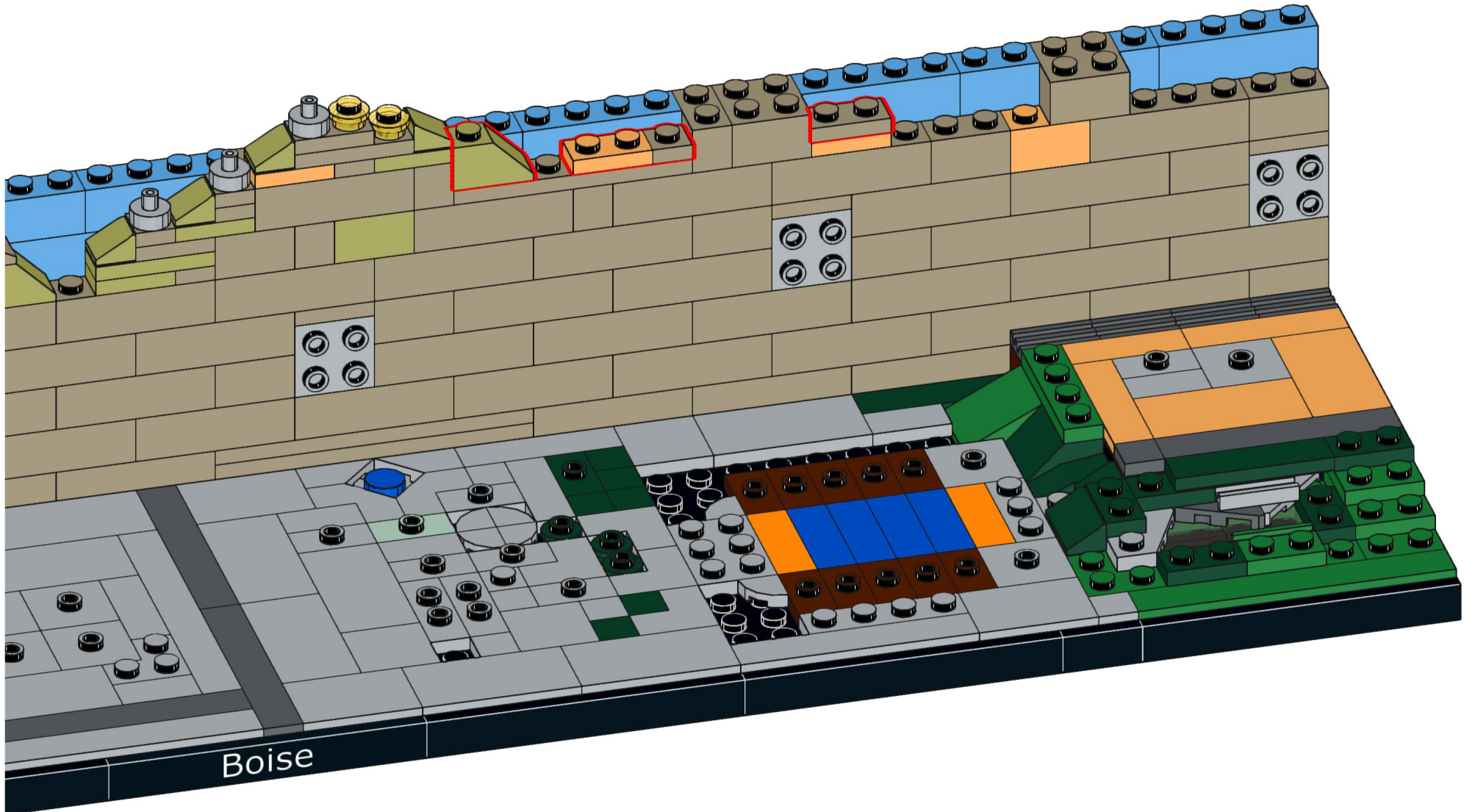
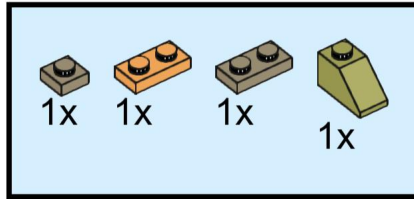

80

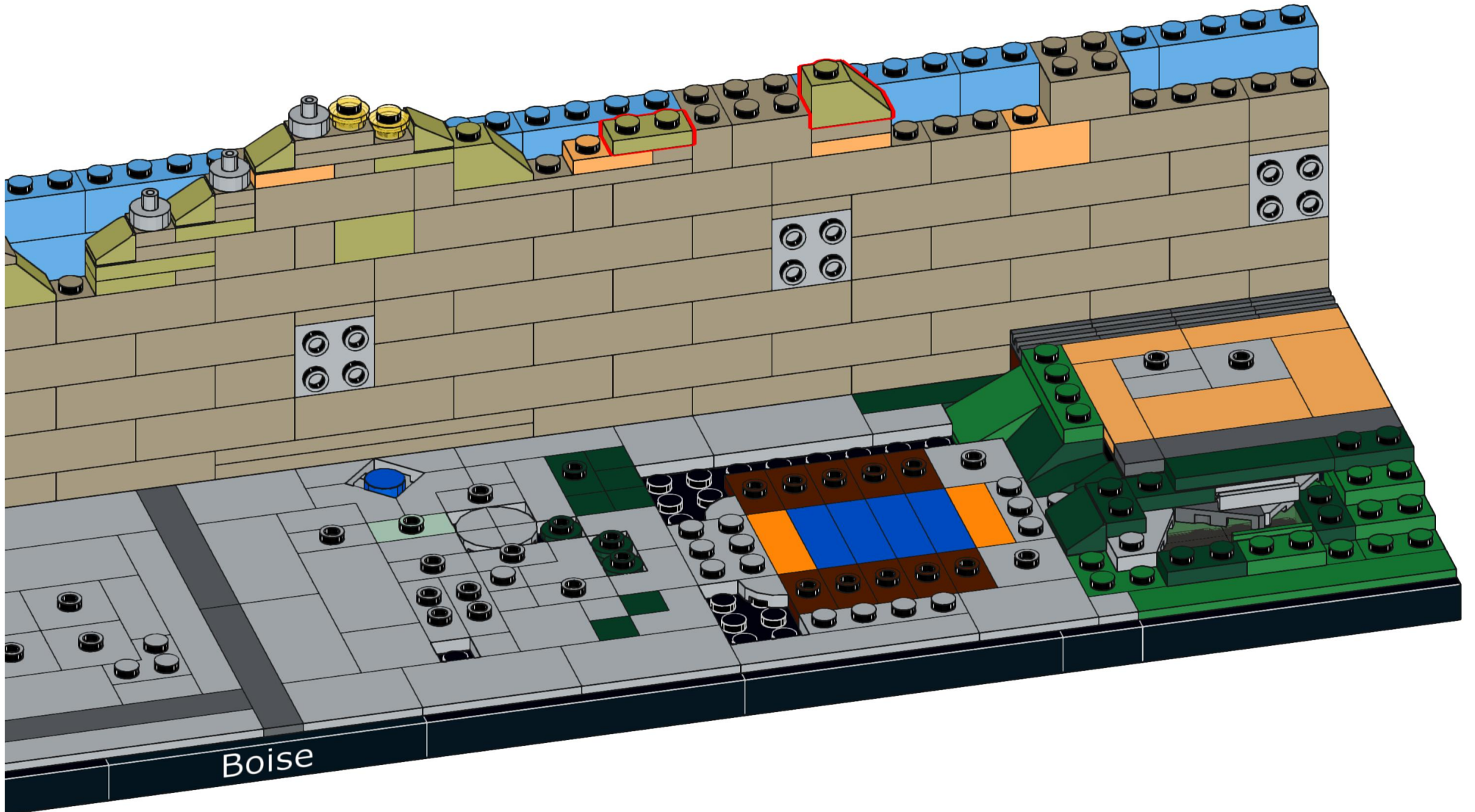
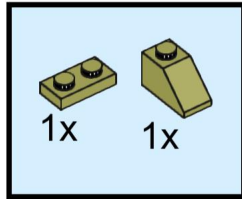

81

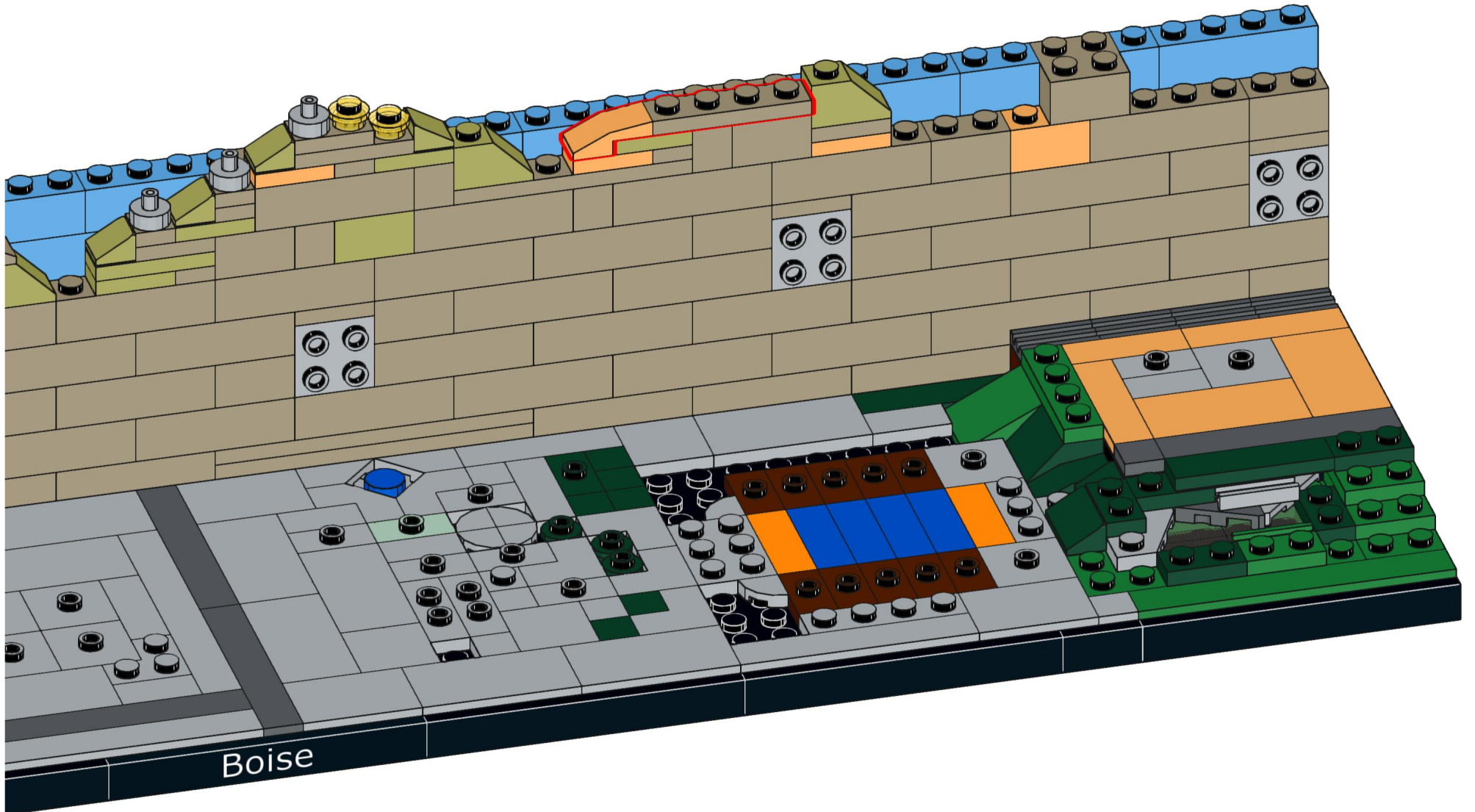
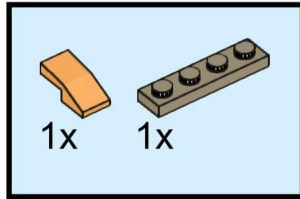

82

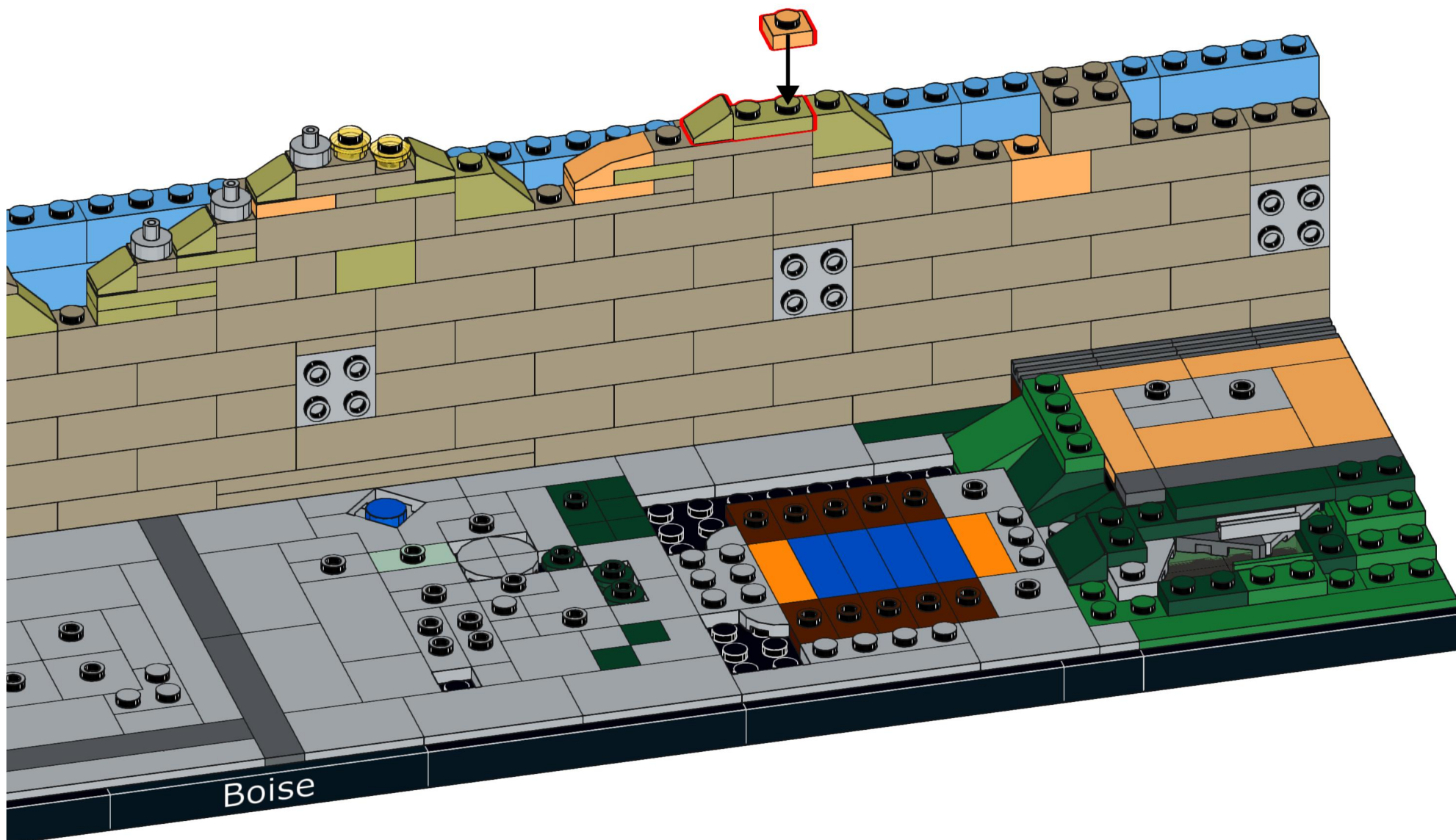
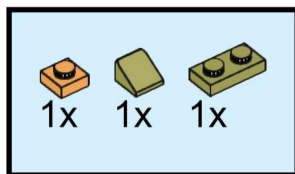

83

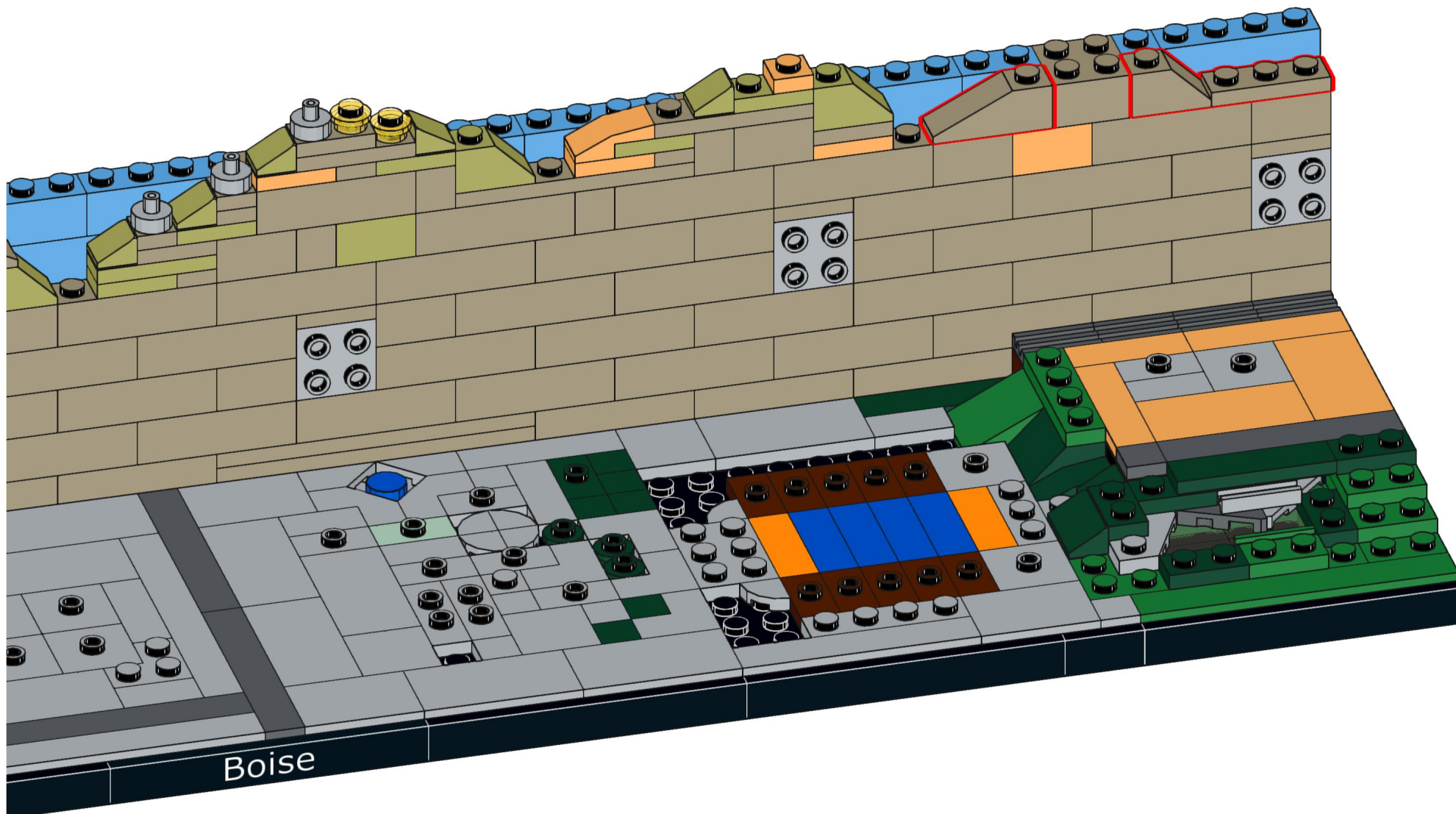
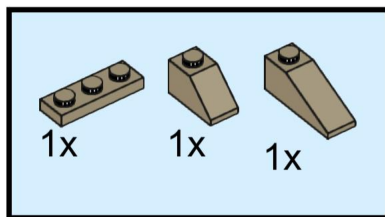

84

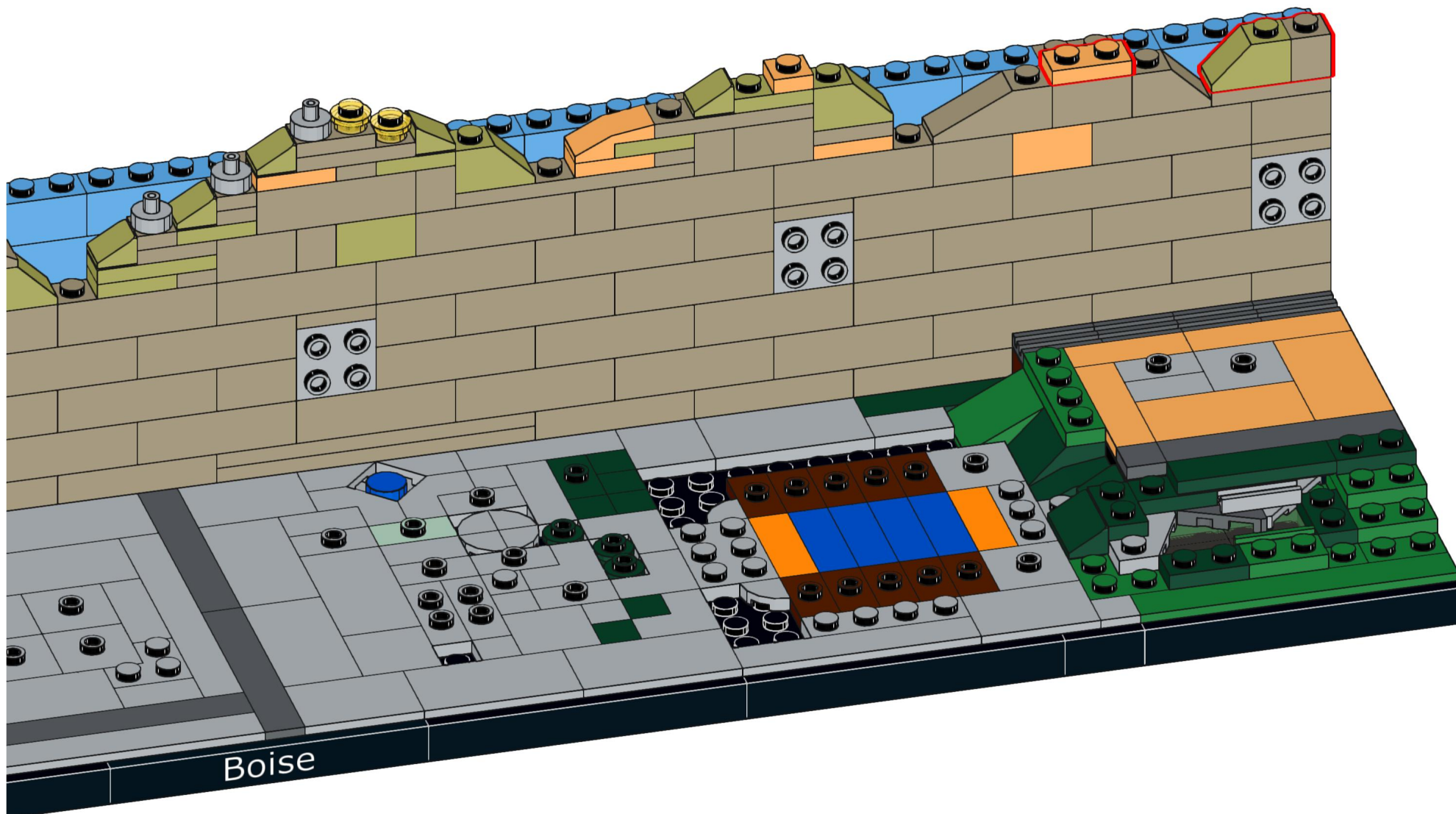
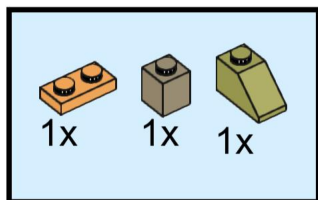

85

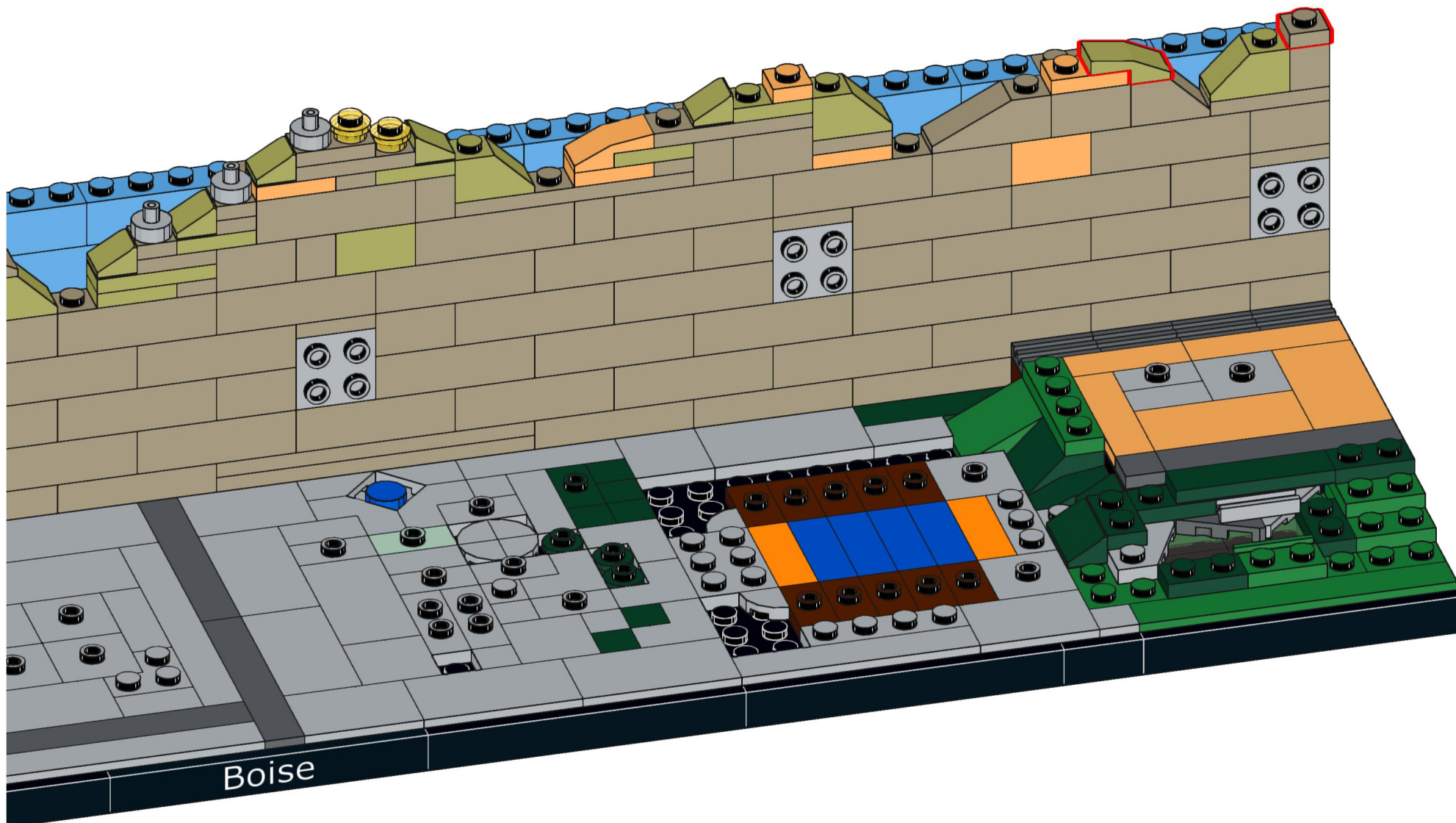
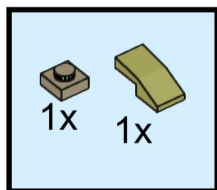

86

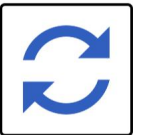
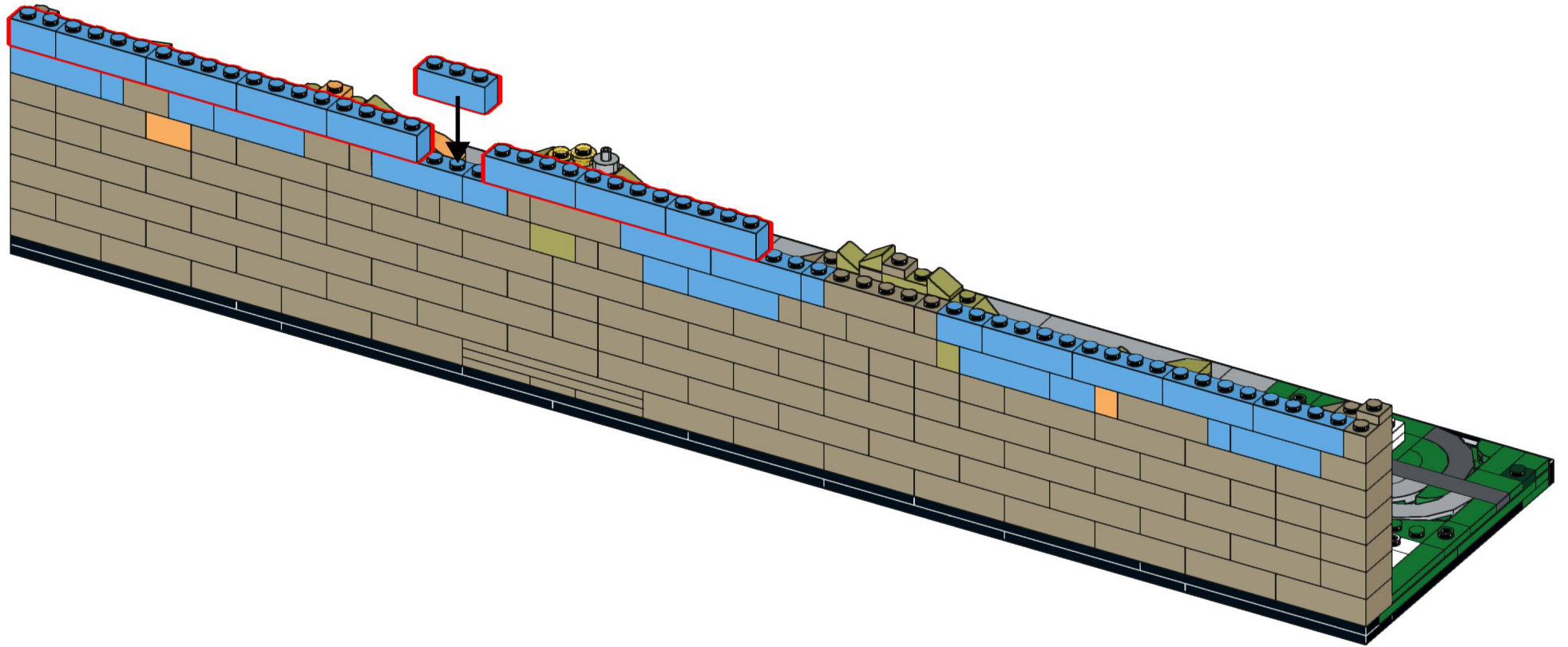
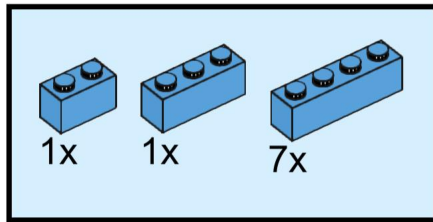

BRICKNOWLOGY

87

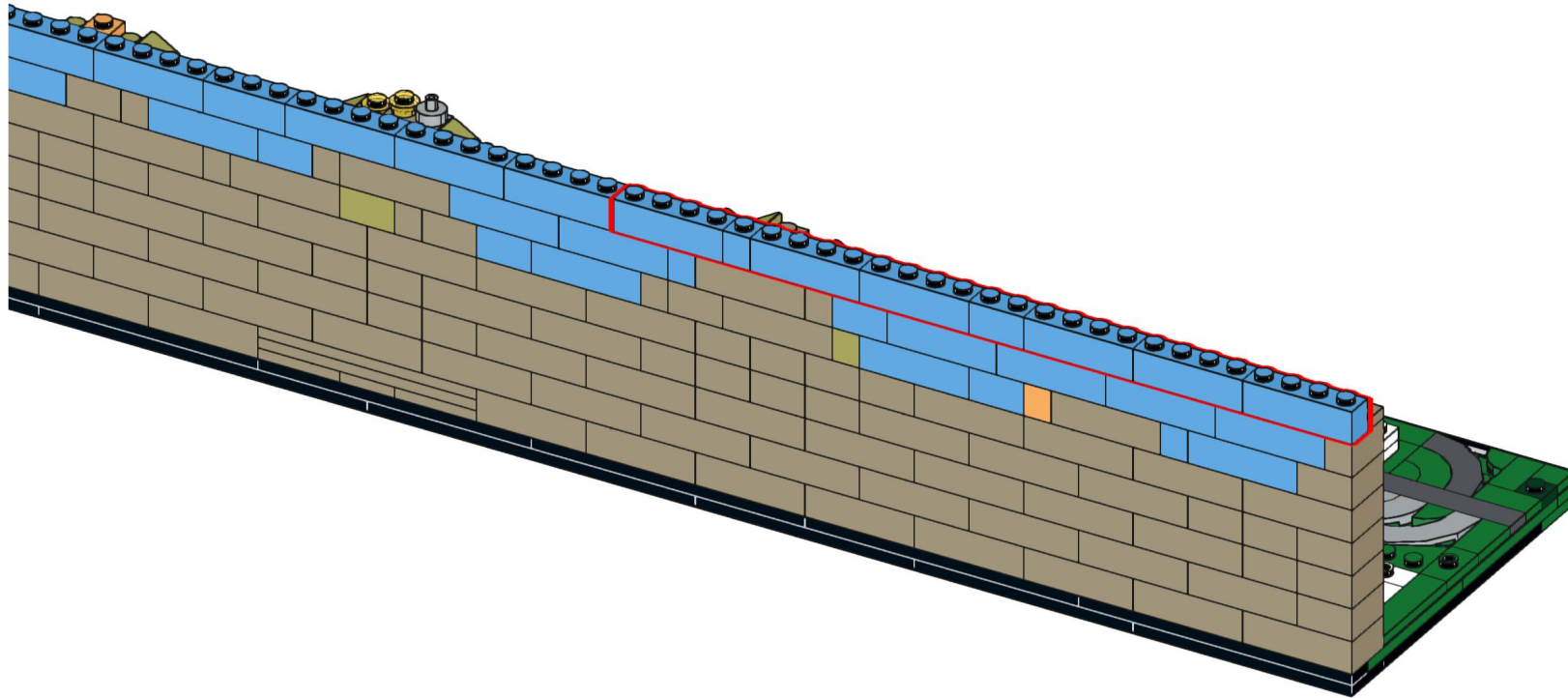
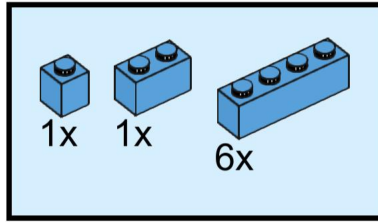

88

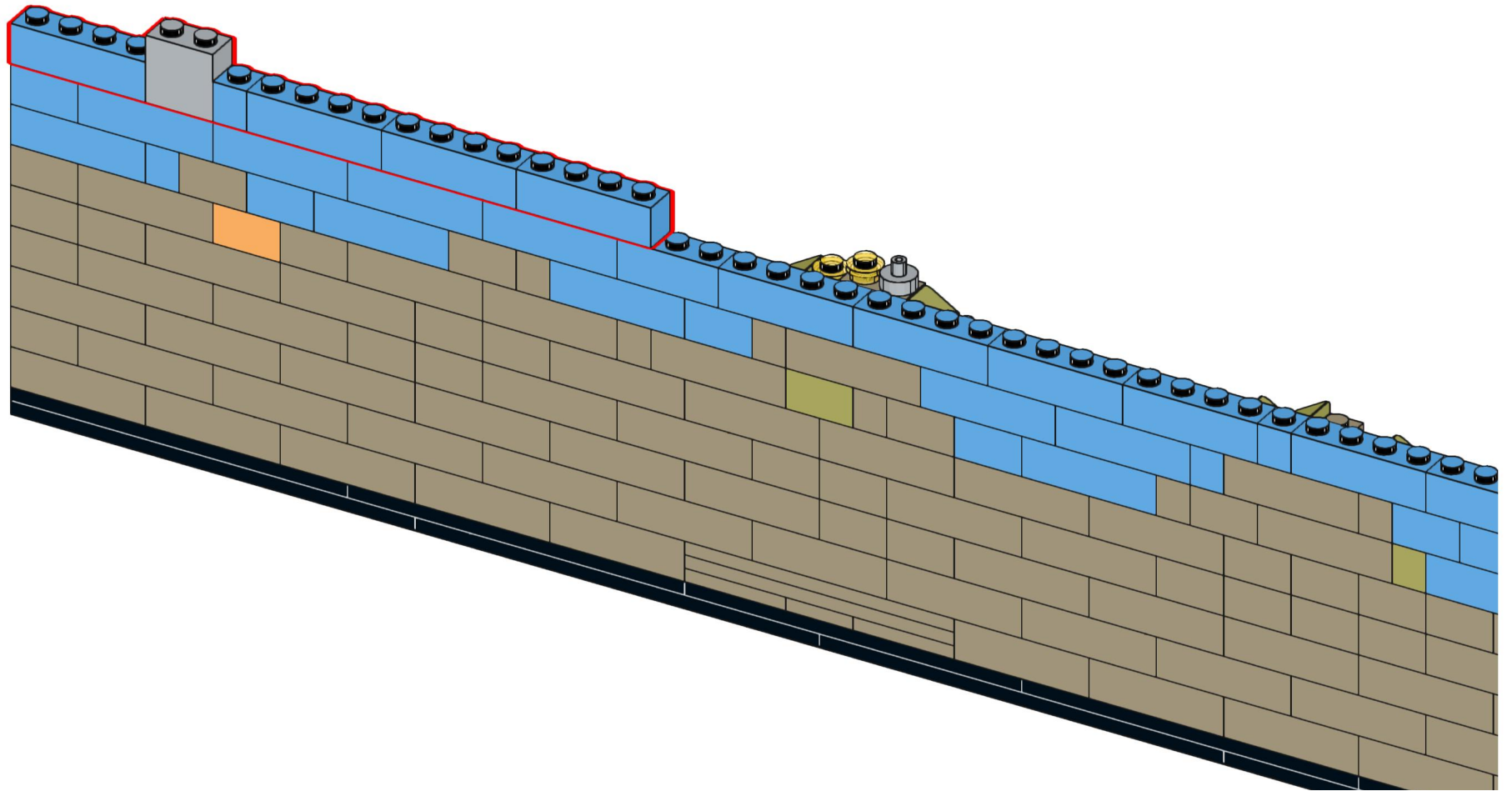
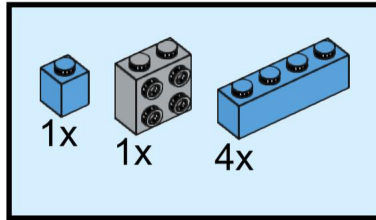

89

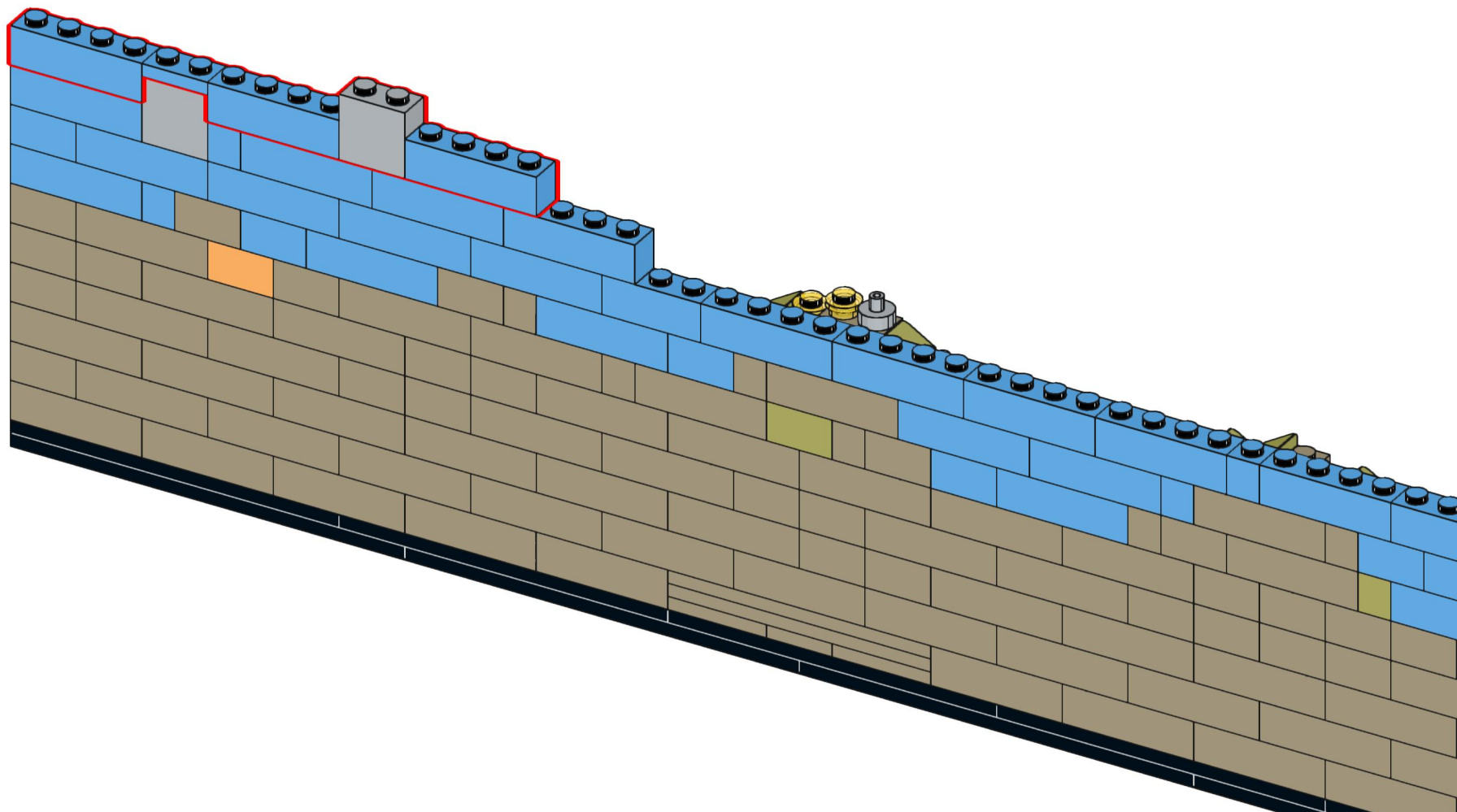
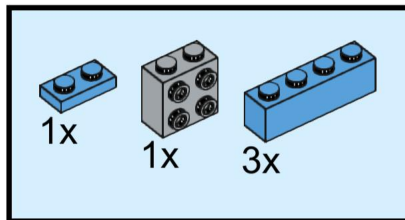

90

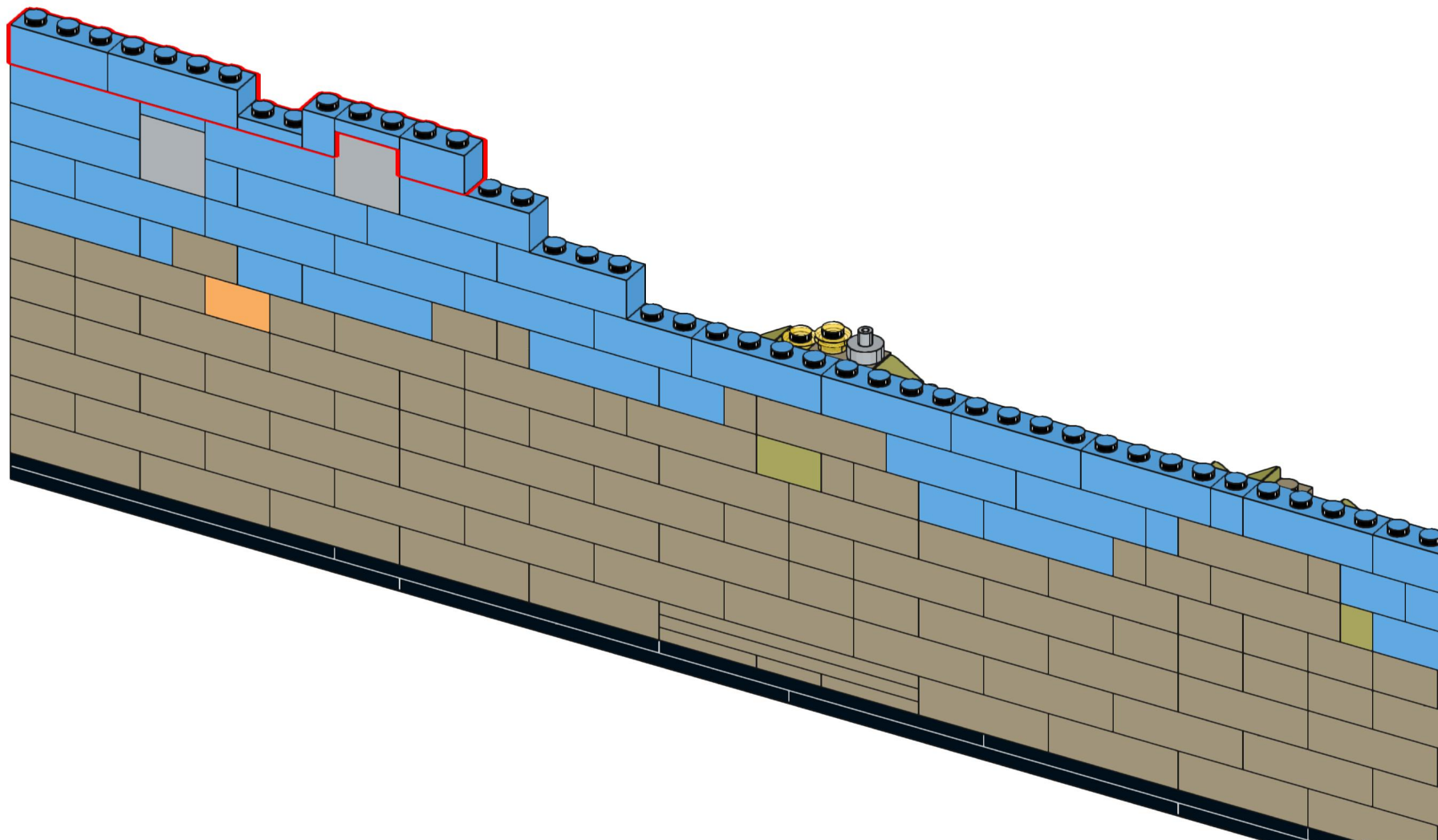
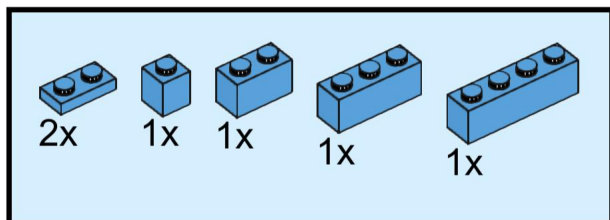

91

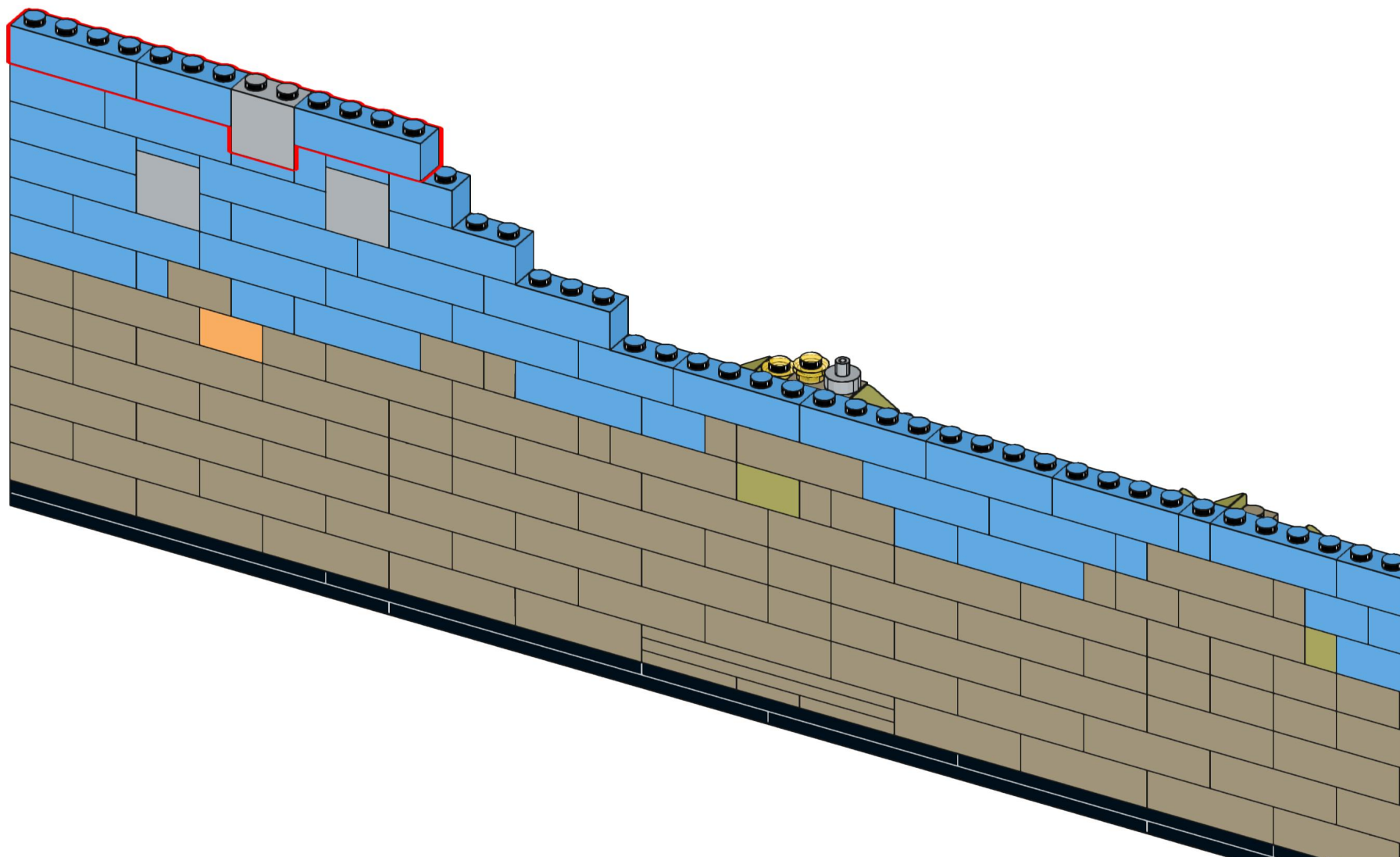
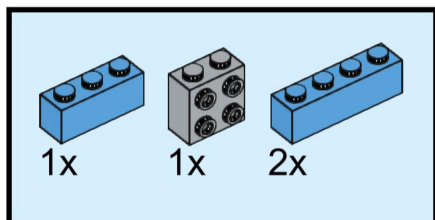

92

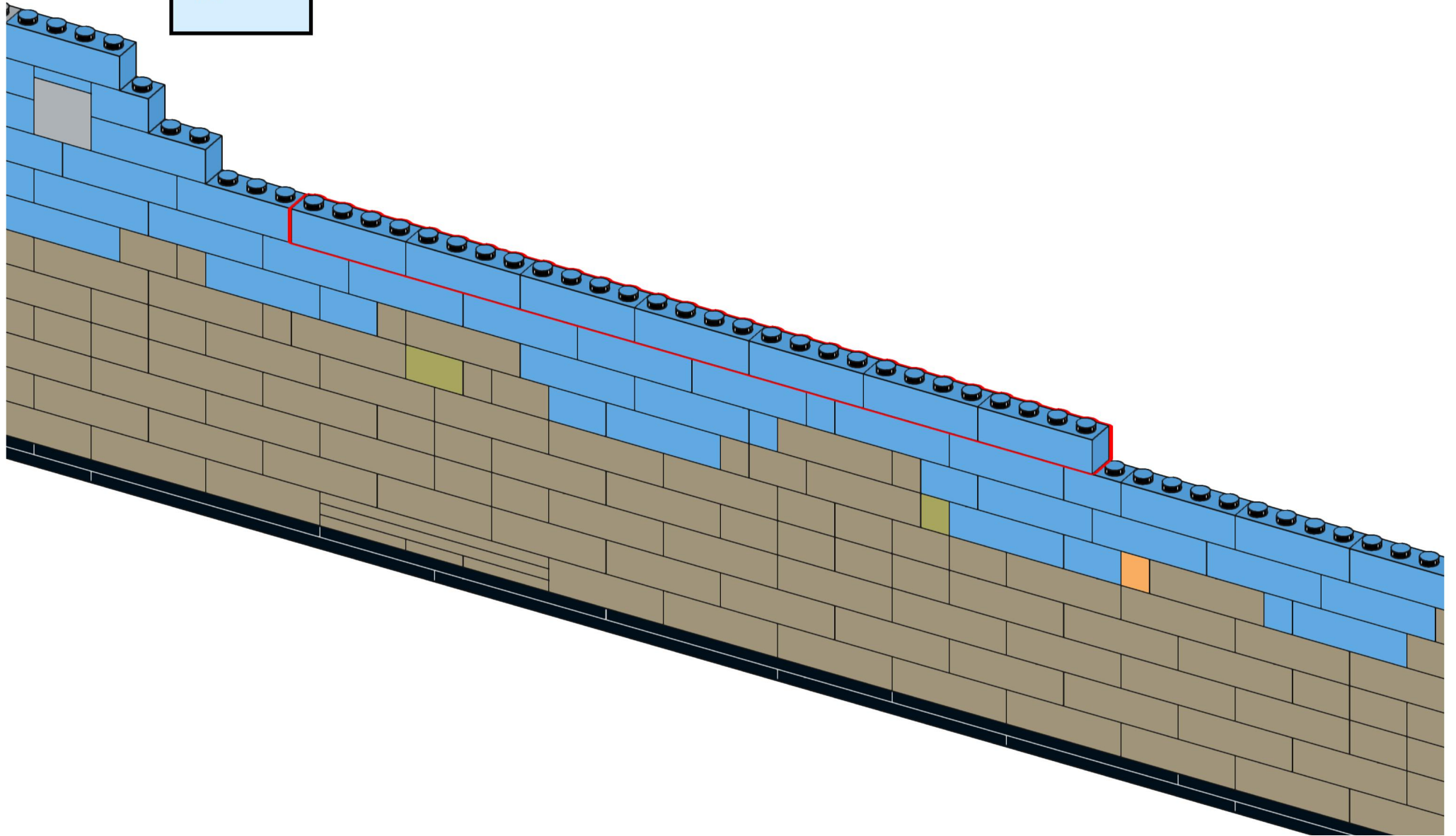
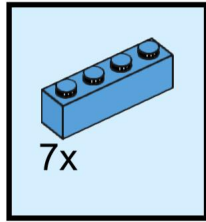

93

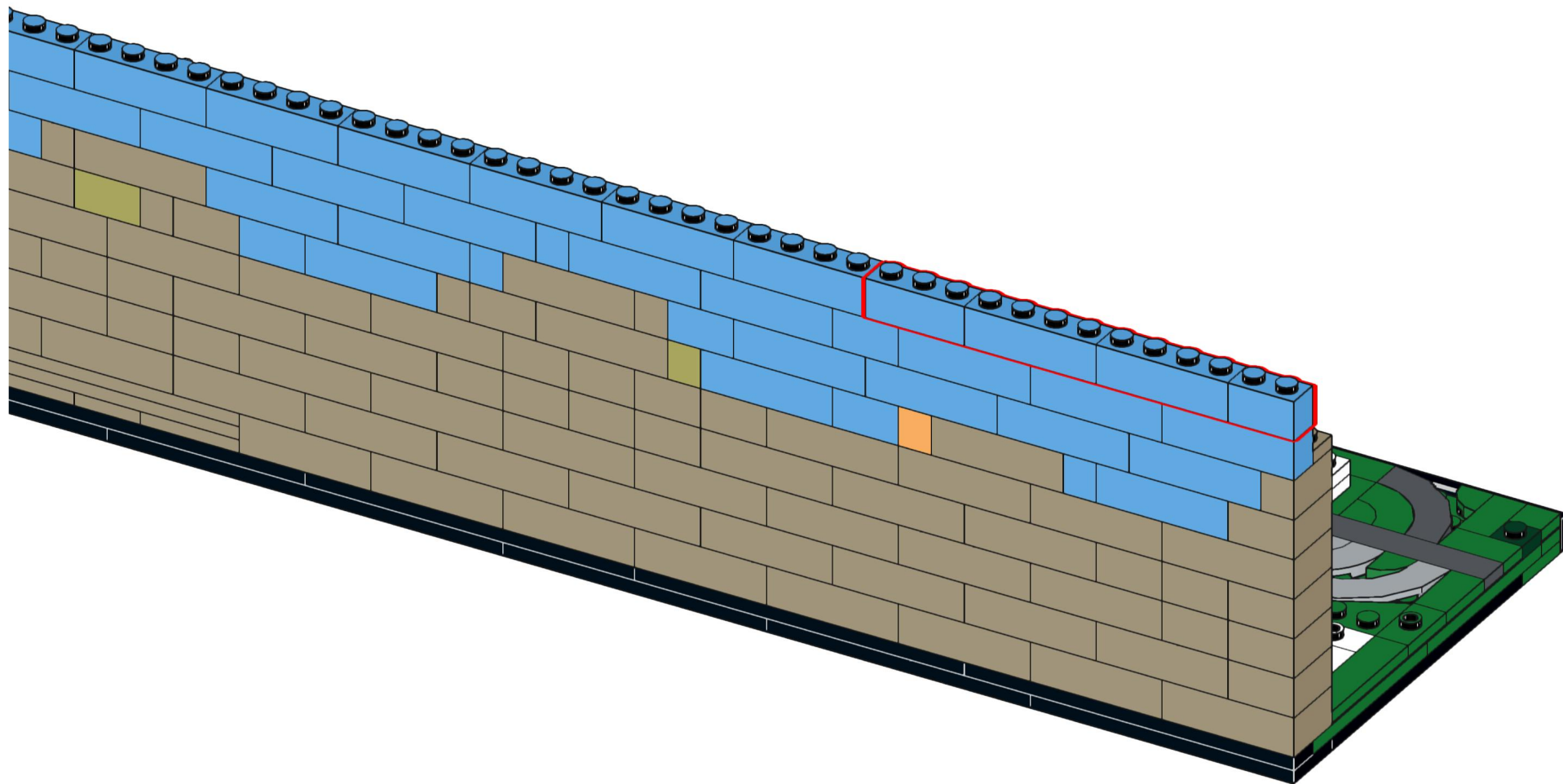
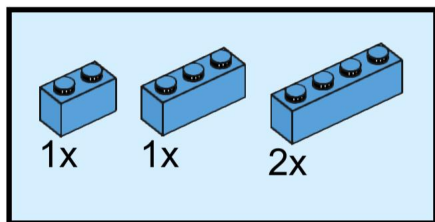

94

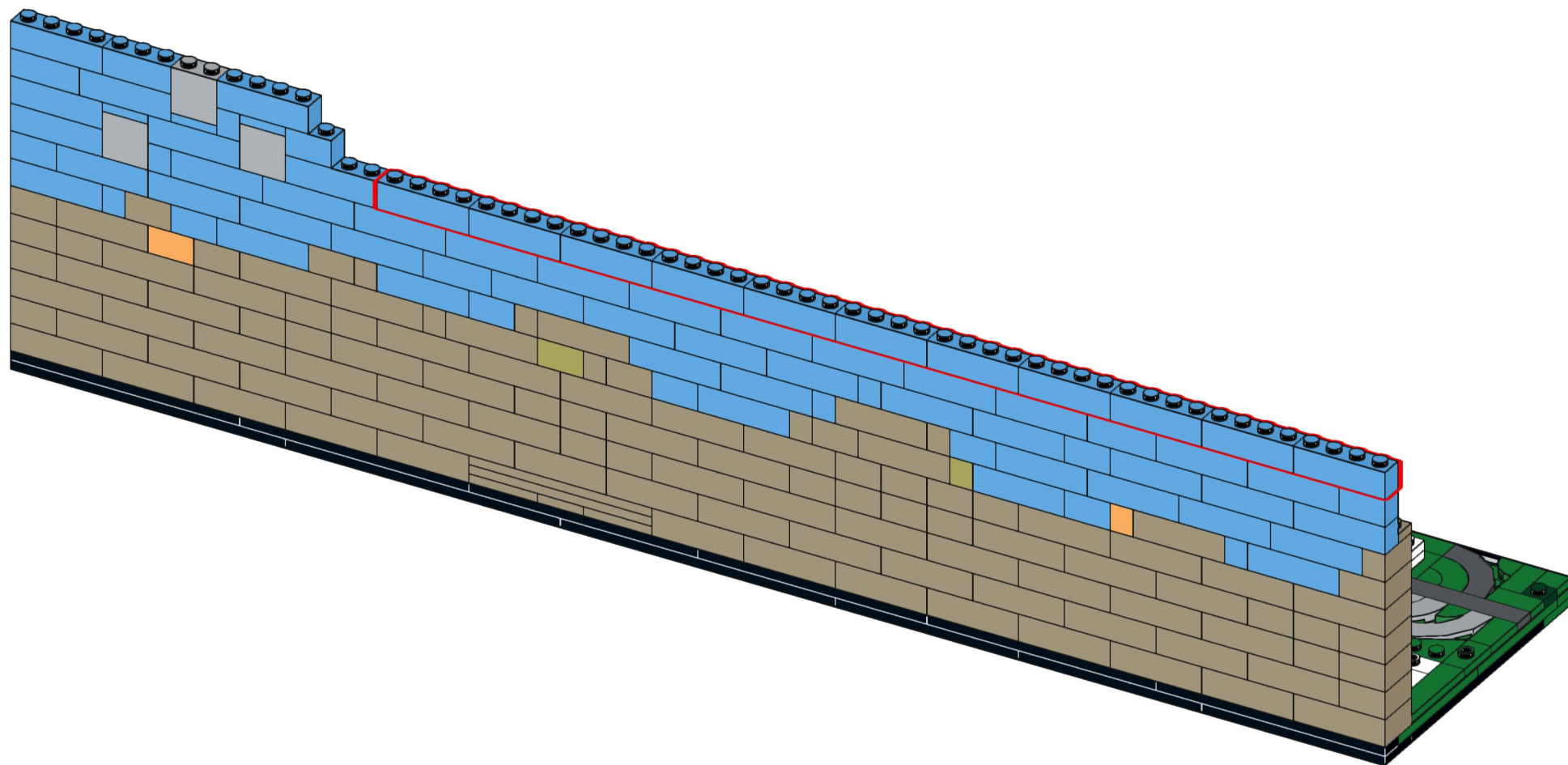
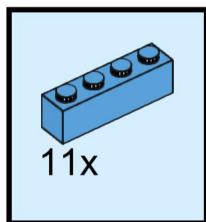

95

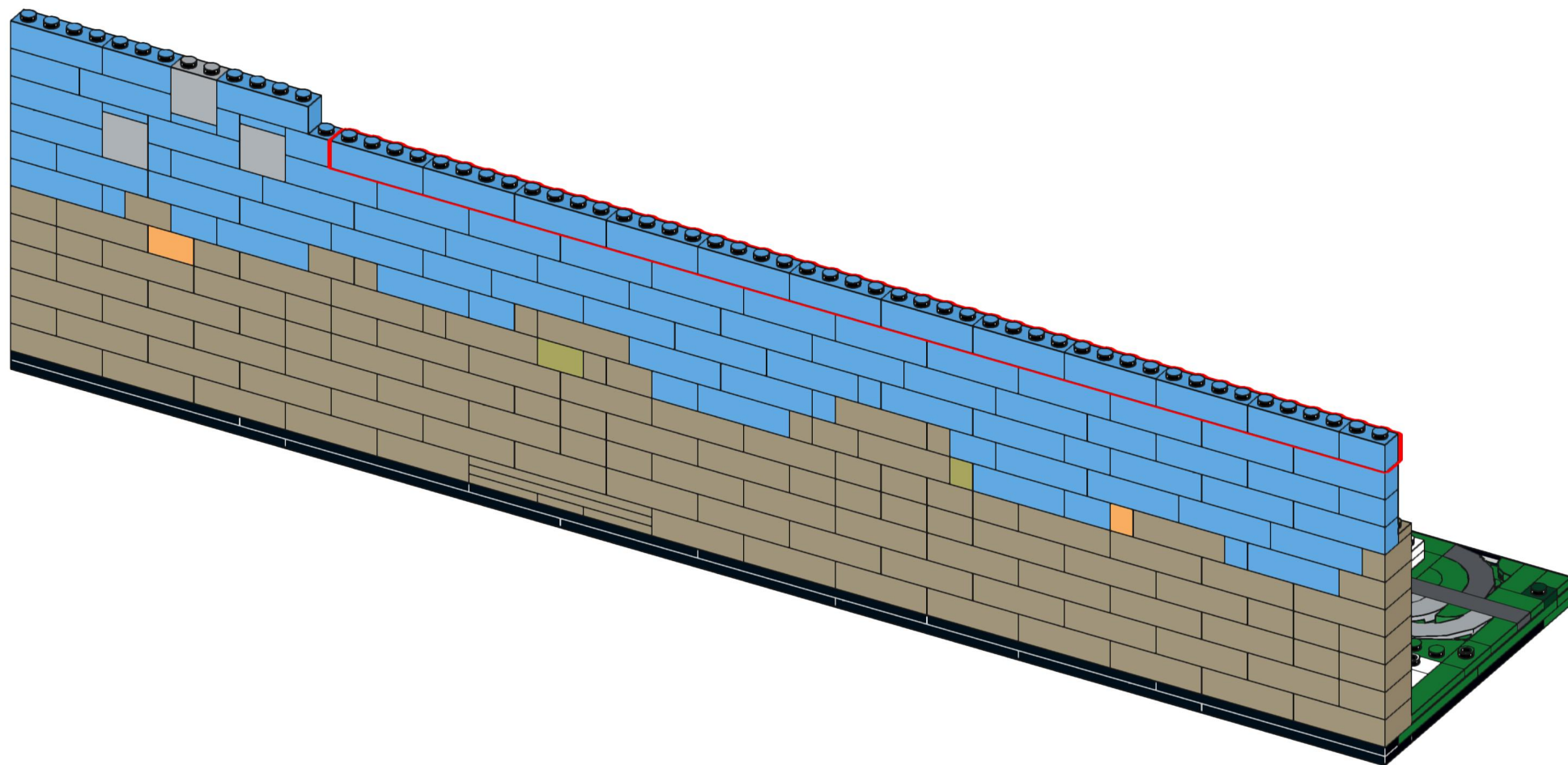
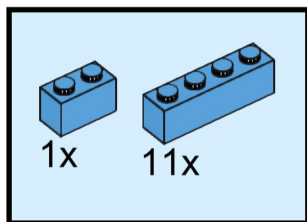

96

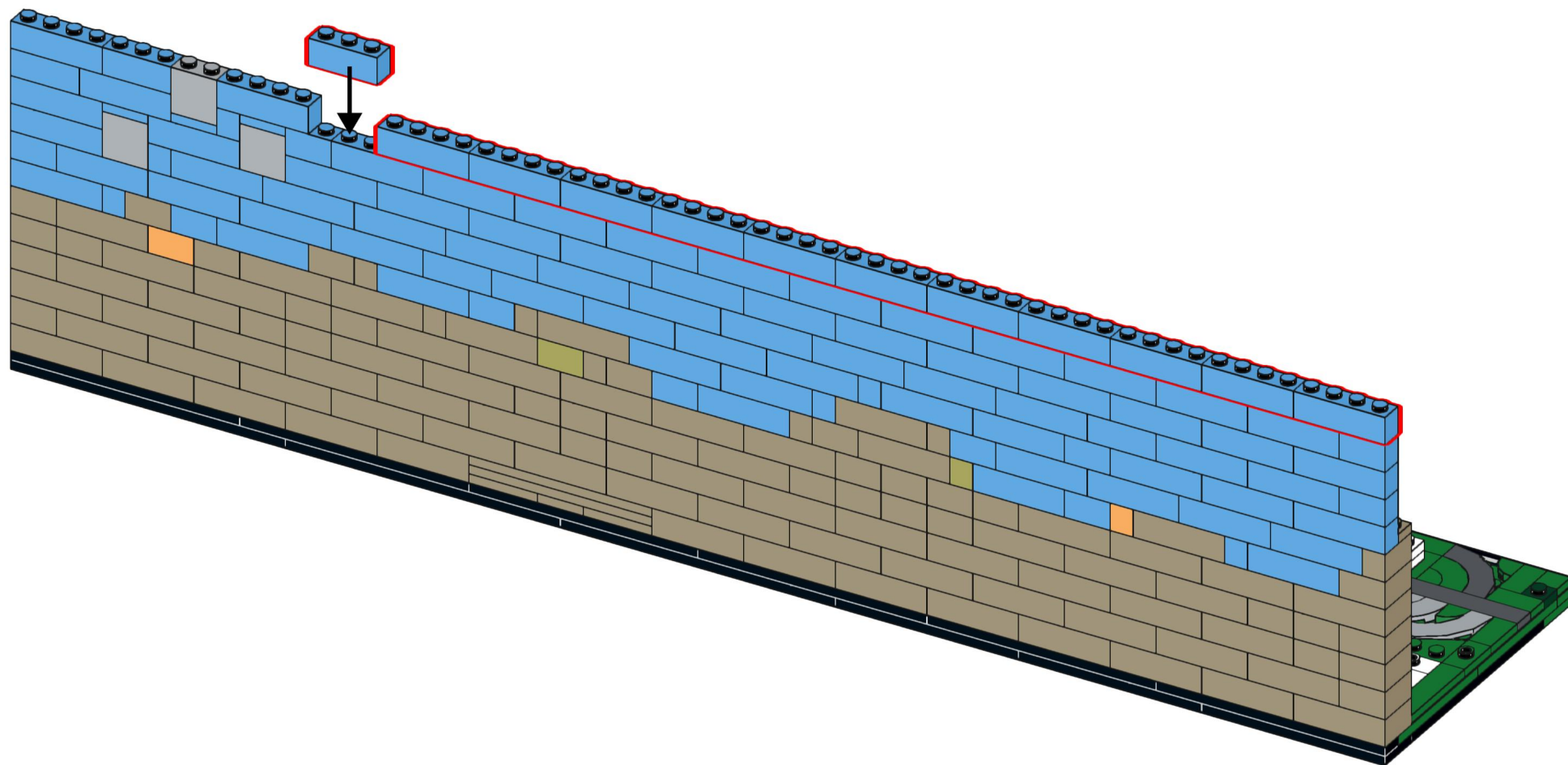
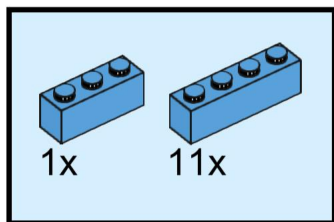

97

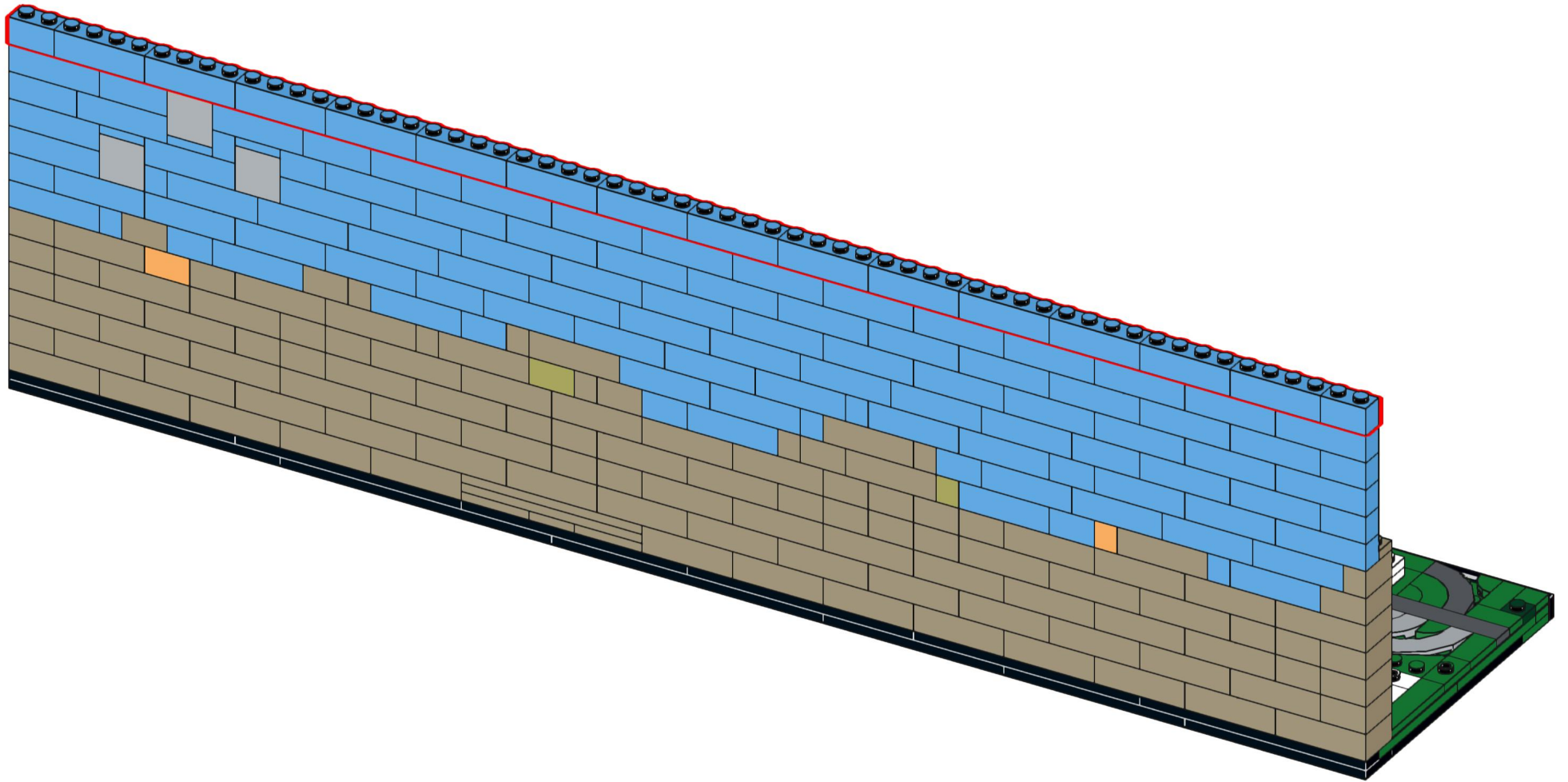
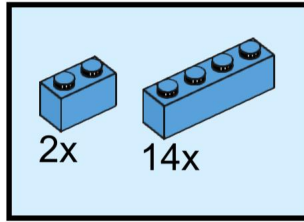

98

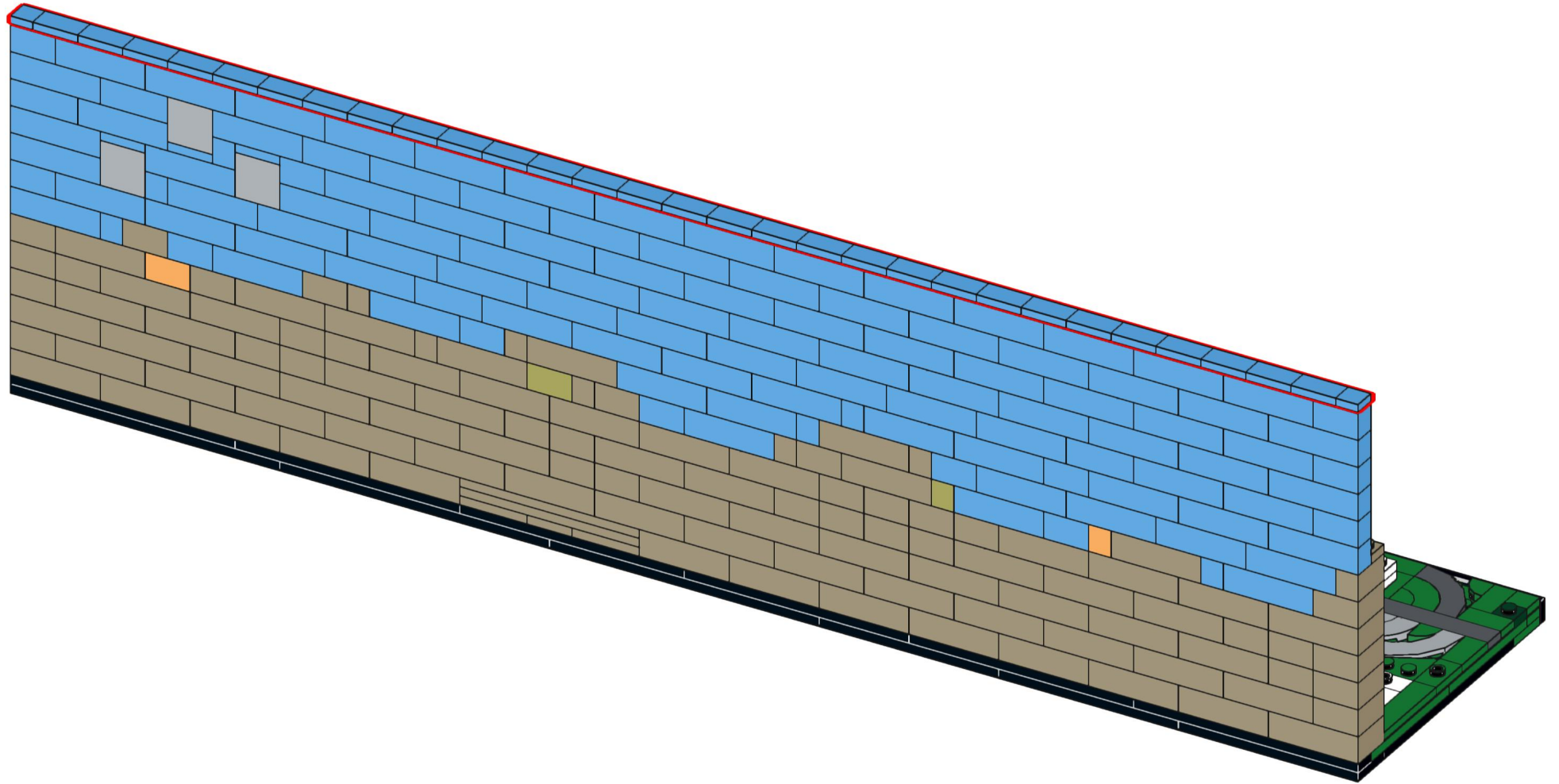
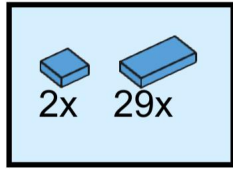

BRICKNOWLOGY

99

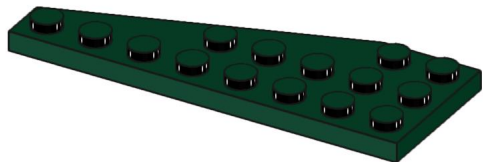
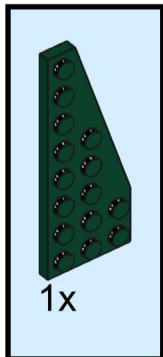
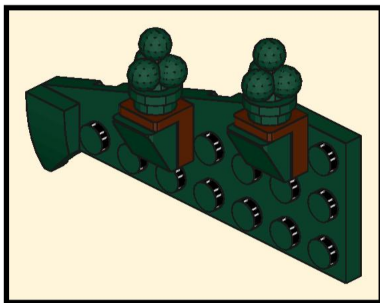

100

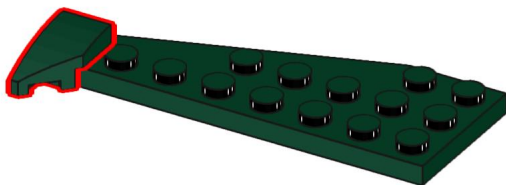

101

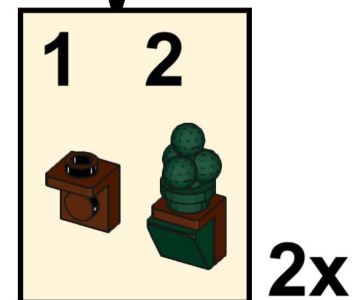
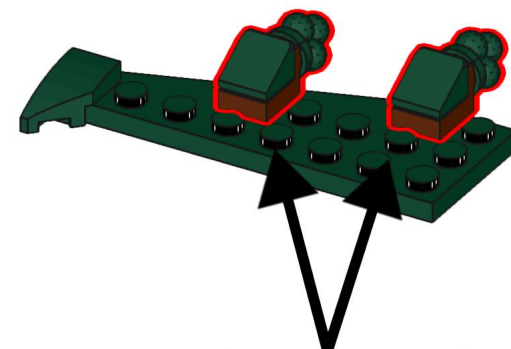
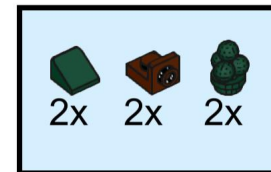

102

